



BUILD WITH
TRUST &
EXCELLENCE



ALUSET

ABOUT US

ALUSET

The Ex-tra benefits of Aluminium

Aluminium is an extremely versatile fenestration material, with a wide range of patterns, shades, and styles to choose from. Aluminium frames are guaranteed to be corrosion-free after a series of treatments before the glass panes are laced into the frames. When compared to other materials, Aluminium section windows have an exceptionally long life expectancy. Temperature differences, extreme weather conditions, or lack of maintenance do not affect these structures.

We at Ganga Aluminium under the brand name Aluset offer the best quality aluminium doors, windows, and sliding systems made from the highest quality raw material. Our collections immaculately complement the modern architectural style.

The attractive qualities of the aluminium elements are their excellent strength for use, even with extreme loads, and guaranteed long lasting, seamless functionality. The versatile metal is used to create a high-performance and sustainable window and door systems that surpass the expectations of fabricators, installers and end-users in India.

Aluset aluminium profiles are par excellence in quality and highly convincing with many promising properties. These profiles are extremely robust and are substantially very low maintenance over their long lives. Moreover, Aluset Doors and Windows Systems are nonflammable, colorfast and 100% recyclable. Thanks to their high strength and load-bearing capacity, elements can be produced in a great miscellany of sizes. All our products are manufactured to reach and exceed paramount standards, every Aluset product delivers matchless performance and signature style.



BENIFITS



Sound Insulation
By installing Noise Cancellation Doors and Windows you can minimize noise pollution levels in your home by as much as a half



Wind Load
The Aluset aluminum windows and doors are stronger and has an extensive performance lifespan as compared to other window materials



Water Tightness
Our aluminum windows and doors are made from innovative profiles to resist from Water, also come with no corrosion for lifetime feature.

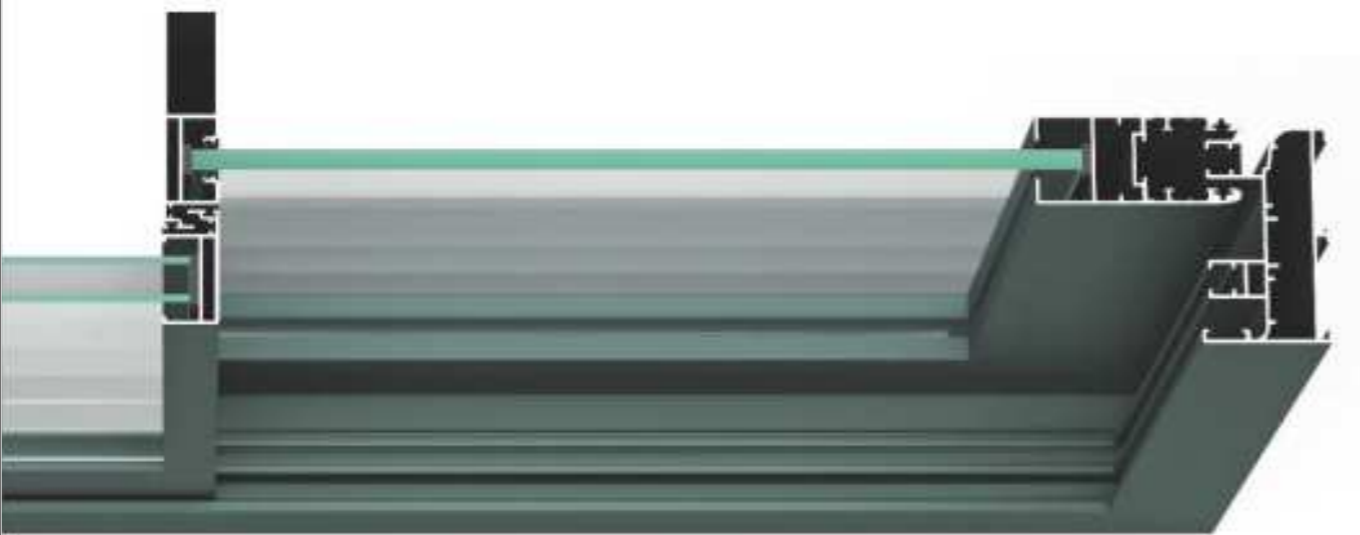

Air Permeability
During these days buildings are very high-rise with glass outer finish, to hold such heavy glass of doors and windows our product comes with extensive capability.



Impact Resistance
Aluminum frames, doors and windows are very light in weight but very strong in comparison to wood and plastic, it has greater absorb capacity against unusual impacts.

ALUSET INDEX

SLIDING WINDOW

25mm Gulf	01
25mm	03
27mm Gulf	09
27mm	10
29mm Gulf	15
29mm Super Slim	17
29mm	19
31mm Gulf	25
32mm Gulf	31
32mm	33
35mm Gulf	39
35mm High-End	45
35x75mm	49
37mm	53

CASEMENT WINDOW & DOOR

28mm	59
40mm	61
50mm	65
50mm S&F	71
65mm S&F	75

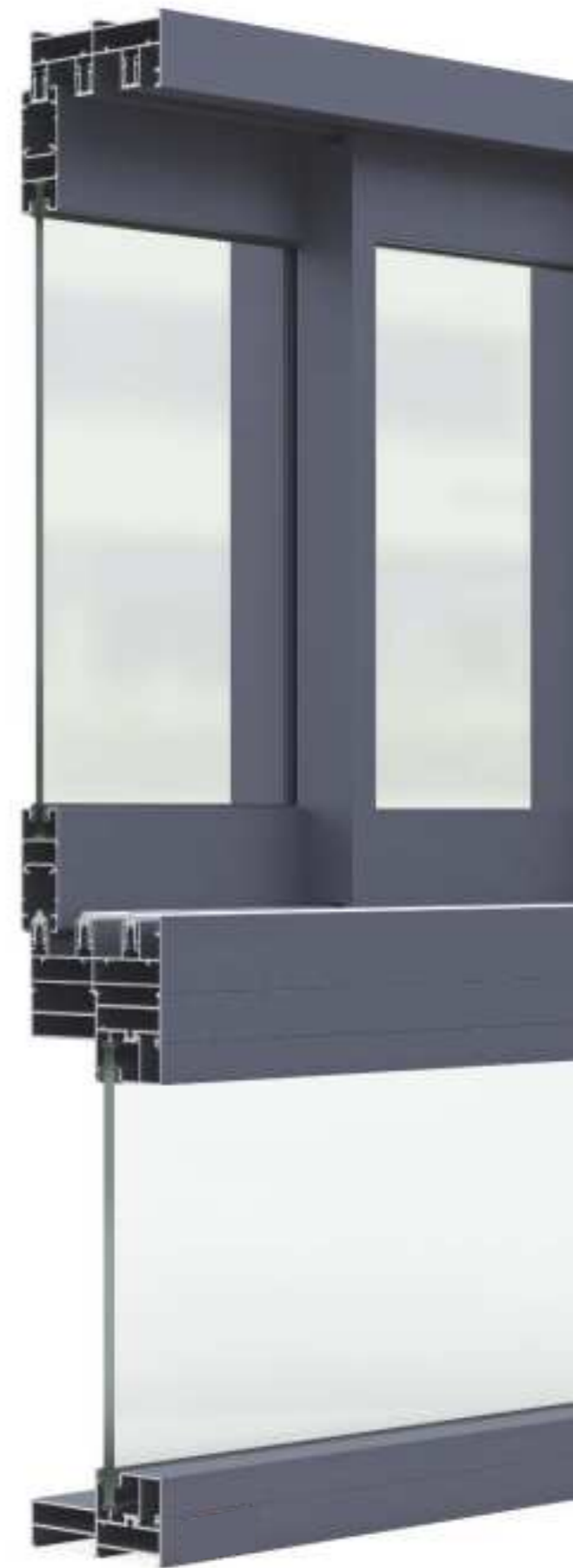



ALUSET

MINIMUM ASSEMBLY TIME - MAXIMUM QUALITY

From a sorting perspective, this new window system fitting has been continually refined. We have unmatched manufacturing and processing speeds for aluminium window extrusions without sacrificing quality. Your home's appearance reveals a lot about who you are. It's no secret that doors and windows play a big role in determining the look and feel of a home.

SLIDING WINDOW

In order to meet the needs of every modern home, we provide a wide variety of window components. You can choose from classic casement windows to Sliding & Folding windows to fit your home's style. For more than just welcoming visitors, your front door plays an important part in weatherproofing and insulating your home. It is the best investment you can make on your home if you install aluminium doors and windows, at a low price, you may improve your home's aesthetic, energy efficiency, and security.

Technical Characteristics

Window Height (Max)
2300mm (Up to 7.5ft)

Sash Height & Width
62mm / 25mm

Interlocking
• Slim Interlock 20mm
• Without Slim Interlock 65mm

Track Option
• 2Track
• 3Track
• 4Track

Track Depth
• 2 Track Top/Bottom 28mm/72mm
• 2 Track Vertical 13mm/76mm
• 3 Track Top/Bottom 28mm/112mm
• 3 Track Vertical 13mm/114mm
• 4 Track Top/Bottom 28mm/145mm
• 4 Track Vertical 13mm/149mm

Glass Range
• Single Glass Sash 5 to 8mm
• Double Glass Sash Upto 18mm

Corner Joint
• Track Joint 90 Degree
• Sash Joint 45 Degree
• Sash Joint 90 Degree
• Slim Interlock 90 Degree

Roller
Fix Single Roller
Fix Double Roller
Adjustable Double Roller

Locking Options
Single Point & Multipoint

 Sound Insulation

 Wind Load

 Air Permeability

 Impact Resistance

 Water Tightness

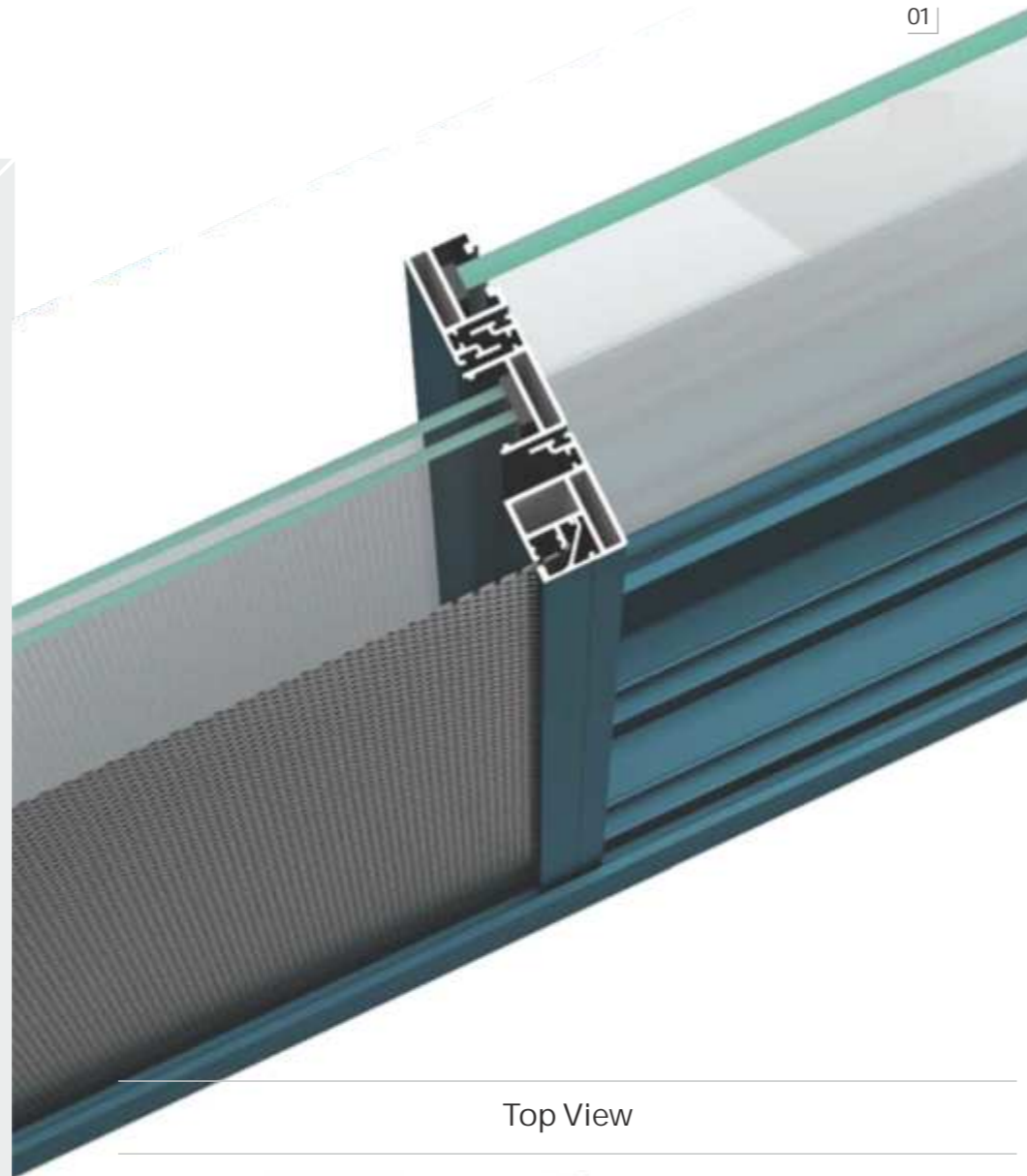

01

Top View

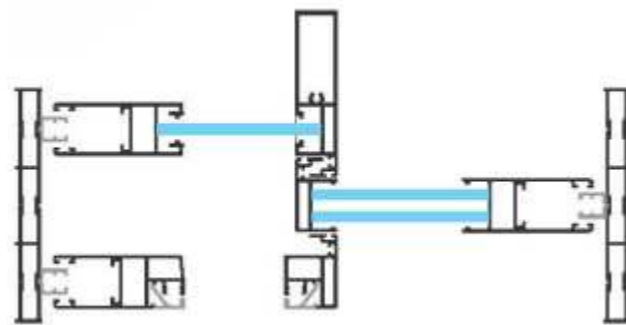

Section Detail

2 Track Top/Bottom Section No: 2545	2 Track Vertical Section No: 2546	Locking Adapter Section No: 2543
3 Track Top/Bottom Section No: 2541	3 Track Vertical Section No: 2542	Top Track Guide Section No: 2544
4 Track Top/Bottom Section No: 2547	4 Track Vertical Section No: 2548	Track Rail Cap Section No: 3535

02

FEELING OF LIBERTY

The primary benefit of the system is in its ability to enhance living circumstances by optimising natural sunlight and reducing the apparent aluminium face width. This helps inhabitants feel more connected to their surroundings and more liberated

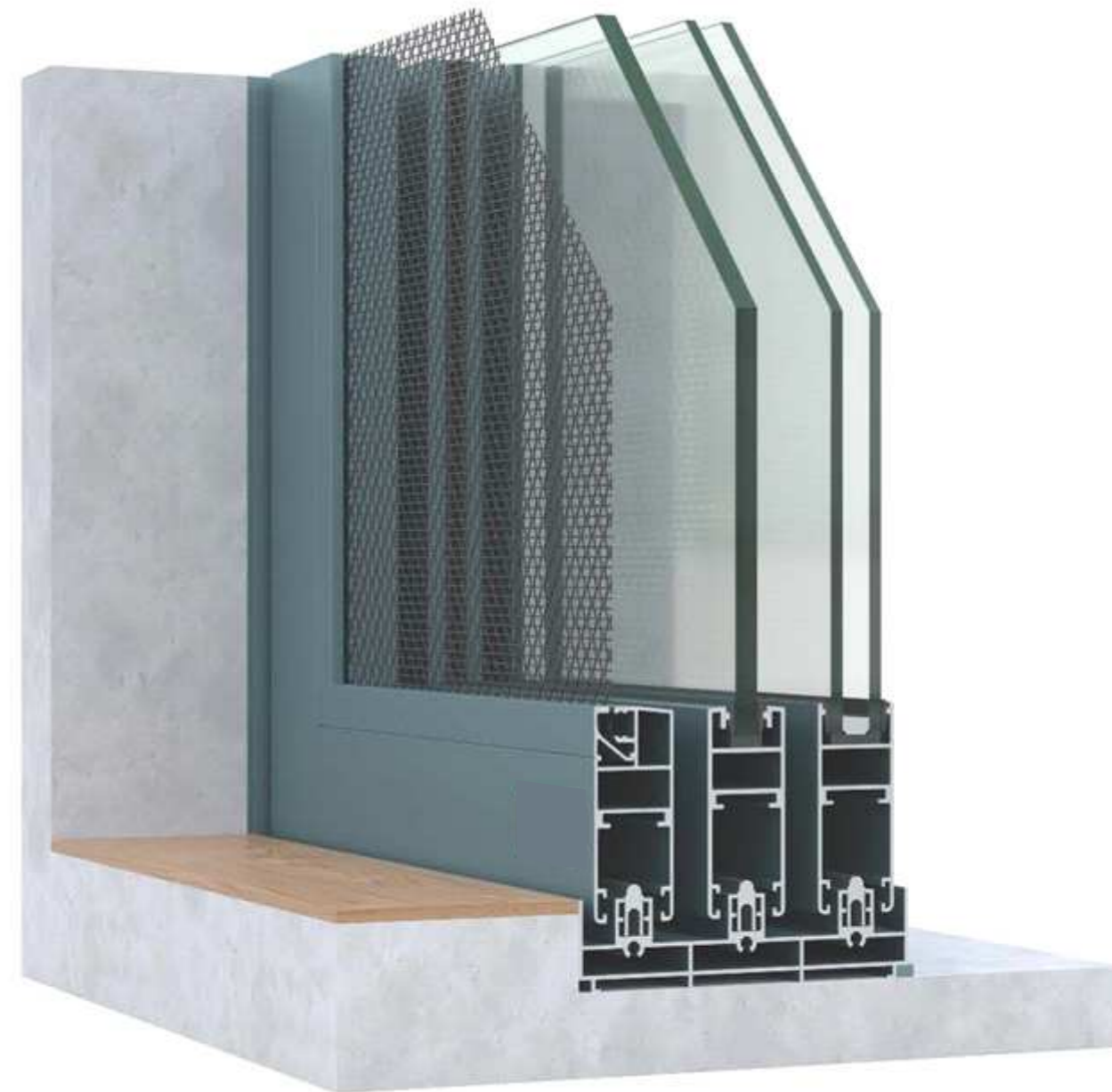

03

04

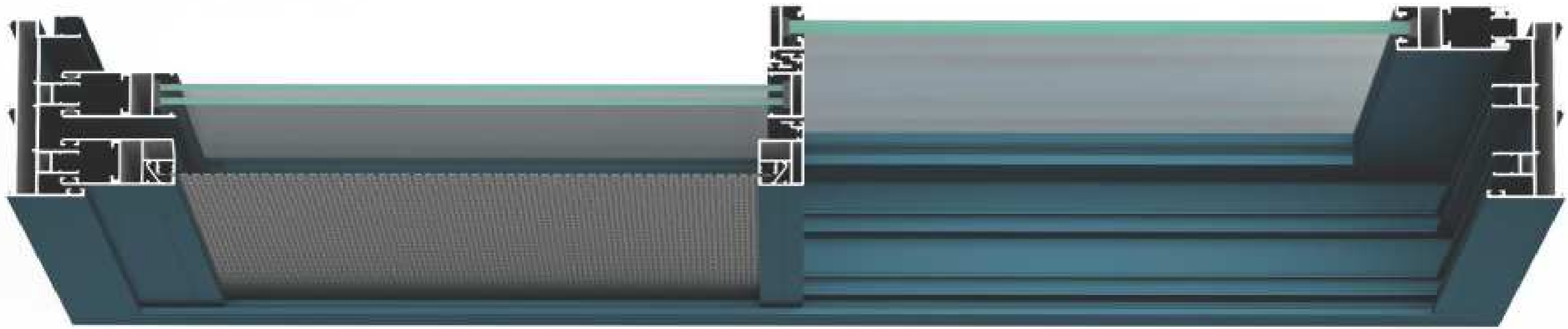

25mm Three Track with Two shutter Assemble

Top View

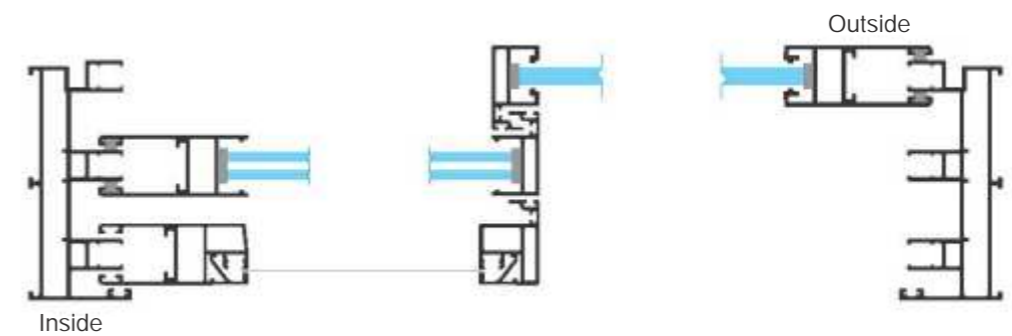
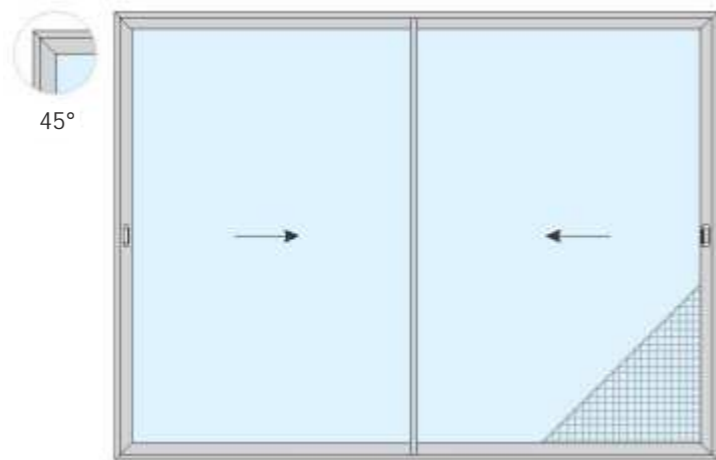

Top & Bottom Shutter

Two Track with 90° Cutting

Key feature

- European design With Standard Euro Groove
- Glazing from 5mm to 18mm
- Smooth & Effortless Movement
- Automatic, Manual Concealed & Multipoint Lock System
- Provision for Insect Screen
- Reinforced Profile Available in Larger Opening
- Design for Mid to Large Size Shutter Sliding
- Bug & Bugler Proof Windows
- Slim Interlock Shutter Available for Single Glass & Double Glass Sliding



Sound Insulation



Air Permeability



Wind Load



Impact Resistance



Water Tightness

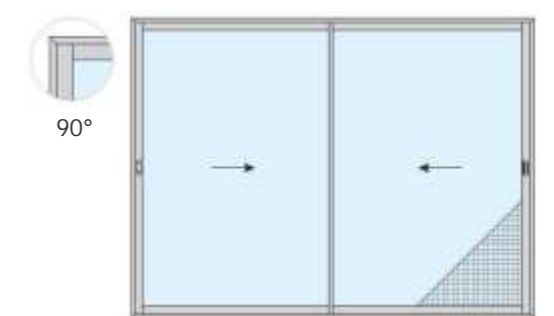
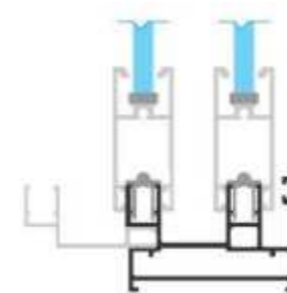

TWO TRACK

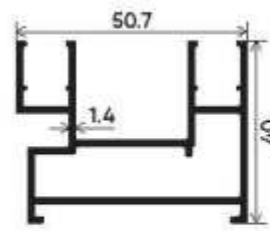

Basic Type
Section Number : V-2501
Weight (kg/mt) : 0.883

THREE TRACK

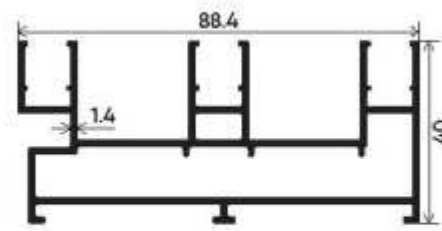

Basic Type
Section Number : V-2502
Weight (kg/mt) : 1.417

TWO TRACK

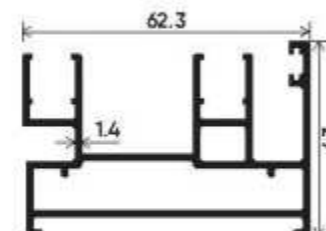

Premium Type
Section Number : V-2503
Weight (kg/mt) : 1.168

THREE TRACK

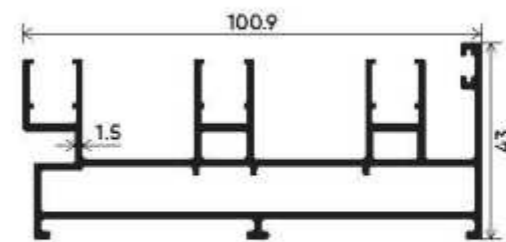

Premium Type
Section Number : V-2504
Weight (kg/mt) : 1.676

TWO TRACK

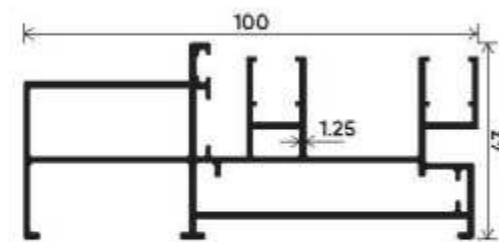

2 in 1 Frame With Grill
Section Number : V-2509
Weight (kg/mt) : 1.435

SHUTTER

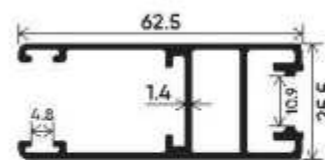

4mm-8mm Single Glass Shutter
Section Number : V-2511
Weight (kg/mt) : 0.835

SHUTTER

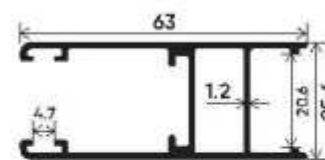

5mm-16mm Glass Shutter
Section Number : V-2512
Weight (kg/mt) : 0.725

SHUTTER

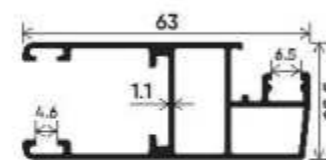

Mosquito screen Shutter
Section Number : V-2513
Weight (kg/mt) : 0.793

SHUTTER

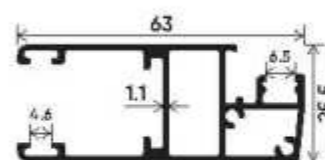

Mosquito Shutter with
Scru Pocket
Section Number : V-2517
Weight (kg/mt) : 0.900

SHUTTER

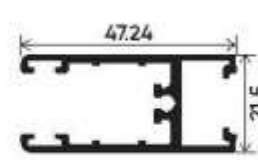

Top & Bottom Shutter
Section Number : V-251B
Weight (kg/mt) : 0.620

SHUTTER

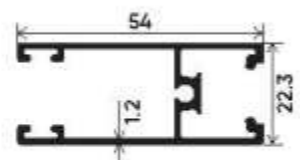

Top Bottom Shutter
Section Number : V-2515
Weight (kg/mt) : 0.579

SHUTTER

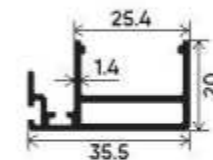

Slim Interlock Shutter
5mm-16mm Glass Shutter
Section Number : V-2523
Weight (kg/mt) : 0.468

INTERLOCK

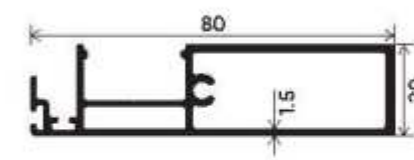

Box Reinforcement Interlock
Section Number : V-2527
Weight (kg/mt) : 0.929

SHUTTER

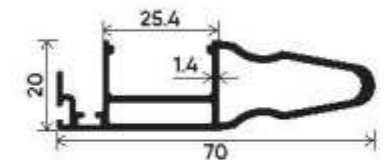

Reinforcement Interlock Shutter
5mm-16mm Glass Shutter
Section Number : V-2522
Weight (kg/mt) : 0.803

SHUTTER

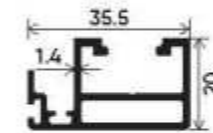

Slim Interlock Shutter
Section Number : V-2528
Weight (kg/mt) : 0.495

INTERLOCK

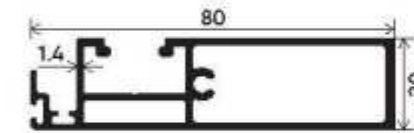

Box Reinforcement Interlock Shutter
Section Number : V-2530
Weight (kg/mt) : 0.994

INTERLOCK

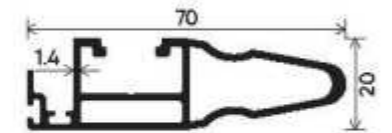

Reinforced Interlock Shutter
Section Number : V-2529
Weight (kg/mt) : 0.800

SHUTTER

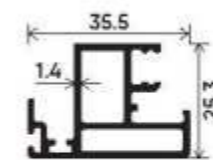

Mosquito Slim Interlock Shutter
Section Number : V-2516
Weight (kg/mt) : 0.566

SHUTTER CLIP

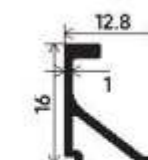

Mosquito Shutter Clip
Section Number : V-2514
Weight (kg/mt) : 0.144

ADDITIONAL TRACK

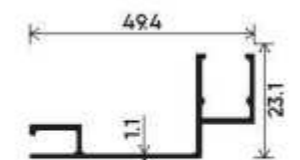

Mosquito Shutter Track Bracket
Section Number : V-2510
Weight (kg/mt) : 0.345

INTERLOCK CLIP

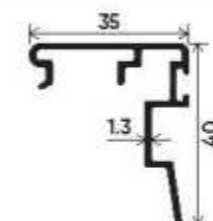

Universal Clip
Section Number : V-2521
Weight (kg/mt) : 0.393

INTERLOCK CLIP

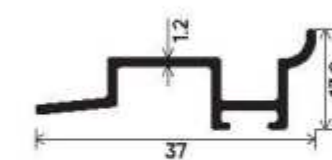

Half Interlock Clip
Section Number : V-2520
Weight (kg/mt) : 0.226

CLIP

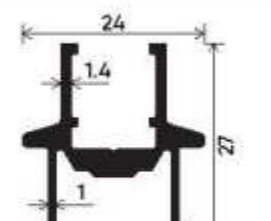

Centre Opening Meeting Section
Section Number : V-2525
Weight (kg/mt) : 0.434

REDUCER CLIP



4-8mm Glass Clip
Section Number : V-2526
Weight (kg/mt) : 0.164

MOSQUITO CLIP

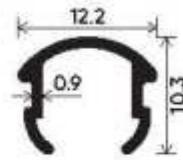

Mosquito Screen Fitting Clip
Section Number : V-2524
Weight (kg/mt) : 0.083

TRACK RAIL CLIP

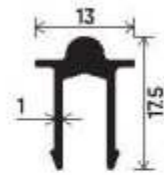

"U" Type
Section Number : V-2532
Weight (kg/mt) : 0.166

TRACK RAIL CLIP

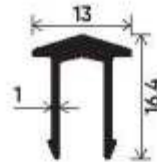

"V"Type
Section Number : V-2531
Weight (kg/mt) : 0.156

TRACK RAIL CAP

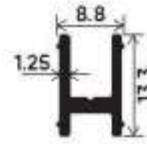

"H" Type Adapter
Section Number : V-2534
Weight (kg/mt) : 0.121

TRACK RAIL CLIP

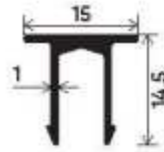

Track Cover Cap
Section Number : V-2533
Weight (kg/mt) : 0.140

LOCKING ROD

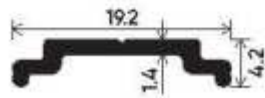

15x20 Euro Groove
Section Number : V-2551
Weight (kg/mt) : 0.156

GEORGIAN BAR

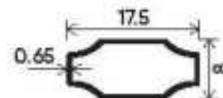

Georgian Bar
Section Number : V-2557
Weight (kg/mt) : 0.073

GEORGIAN BAR

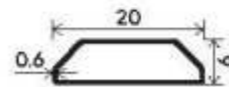

Georgian Bar
Section Number : V-2556
Weight (kg/mt) : 0.073

GRILL SUPPORT

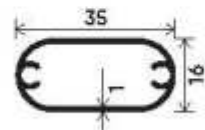

Grill Support
Section Number : V-2552
Weight (kg/mt) : 0.276

GRILL SUPPORT

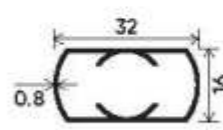

Grill Support Pipe with Safety rod
Section Number : V-2553
Weight (kg/mt) : 0.250

GRILL SUPPORT

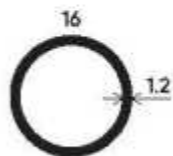

Grill Fitting Tube Cover
Section Number : V-1002
Weight (kg/mt) : 0.164



Technical Characteristics

Window Height (Max)
2500mm (Up to 8.2ft)

Sash Height & Width
65mm / 27mm

Interlocking
• Slim Interlock 20mm
• Without Slim Interlock 65mm

Track Option
• 2Track
• 3Track
• 4Track

Track Depth
• 2 Track Top/Bottom 28mm/74mm
• 2 Track Vertical 13mm/78mm
• 3 Track Top/Bottom 28mm/114mm
• 3 Track Vertical 13mm/116mm
• 4 Track Top/Bottom 28mm/147mm
• 4 Track Vertical 13mm/151mm

Glass Range
• Single Glass Sash 5 to 8mm
• Laminated Glass Sash 11 to 15mm
• Double Glass Sash Upto 20mm

Corner Joint
• Track Joint 90 Degree
• Sash Joint 45 Degree
• Slim Interlock 90 Degree

Roller
Fix Single Roller
Fix Double Roller
Adjustable Double Roller

Locking Options
Single Point & Multipoint

 Sound Insulation

 Wind Load

 Air Permeability

 Impact Resistance

 Water Tightness



45° Sash Joint



90° Interlock Joint



90° Frame Joint

Section Detail

2 Track Top/Bottom Section No: 2755	2 Track Vertical Section No : 2756	Locking Adapter Section No : 2543
3 Track Top/Bottom Section No: 2751	3 Track Vertical Section No: 2752	Top Track Guide Section No: 2544
4 Track Top/Bottom Section No: 2757	4 Track Vertical Section No : 2758	Track Rail Cap Section No: 3535
Slim Interlock SGU Section No: 2733	Box Reinforcement Section No : 2734	Universal Interlock Section No : 2735

Top View

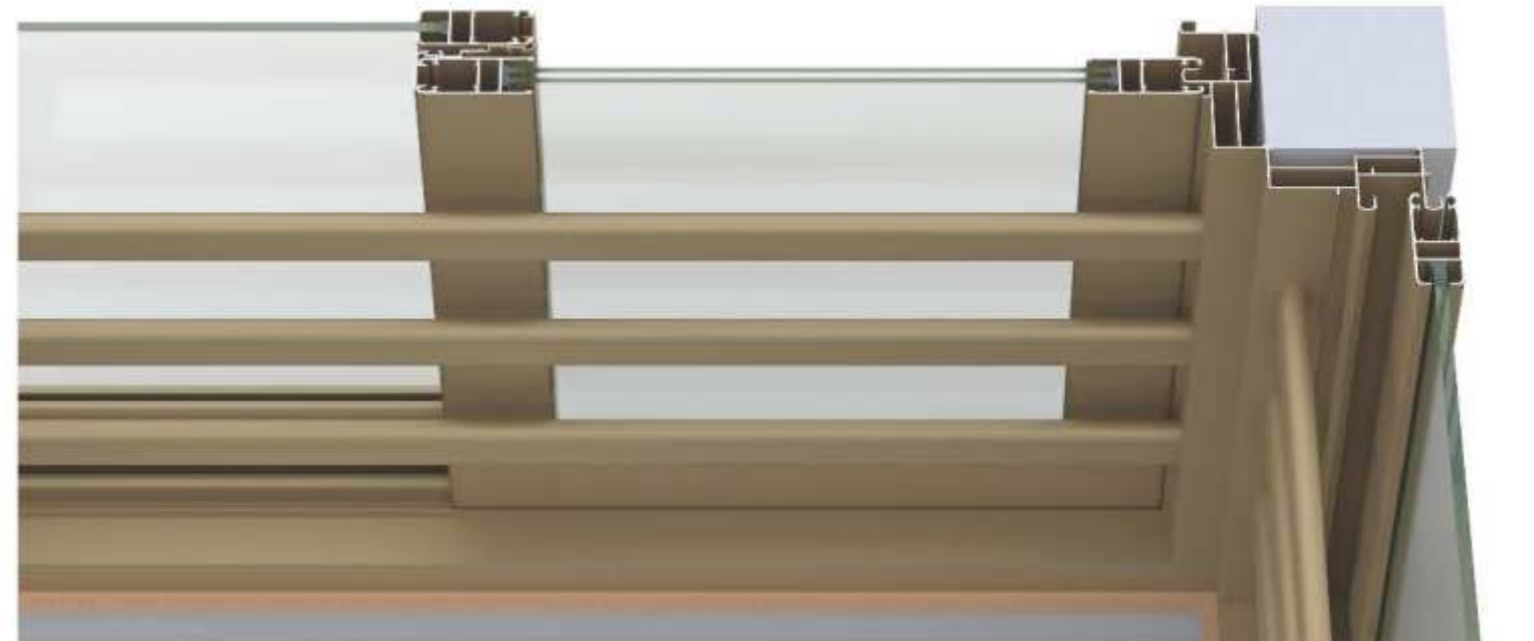
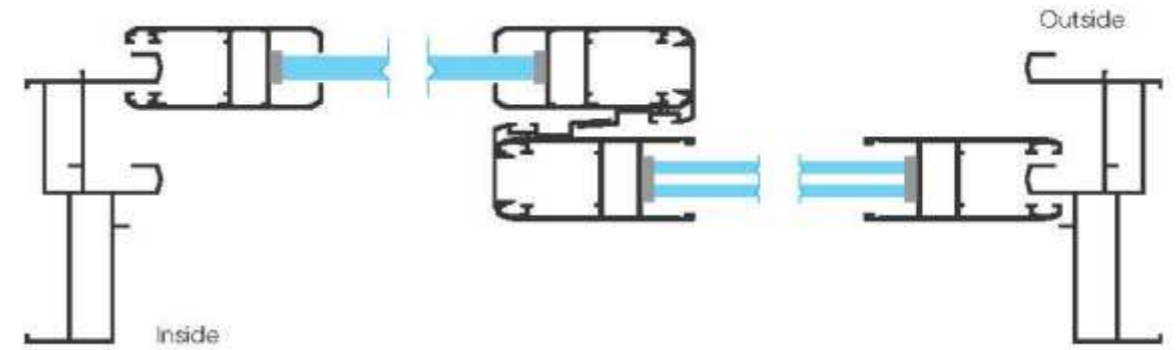

Key feature

- European design
- Glazing from 5mm to 20mm
- Smooth & Effortless in Movement
- Automatic, Manual Concealed & Multipoint Lock System
- Provision for Insect Screen
- Reinforced Profile Available in Larger Opening
- Design for Mid to Large Size Shutter Sliding
- Bug & Bugler Proof Windows
- Slim Interlock Shutter Available for Single Glass & Double Glass Sliding

 Sound Insulation

 Wind Load

 Air Permeability

 Impact Resistance

 Water Tightness

<p>TWO TRACK</p> <p>Premium Type Section Number : V-2701 Weight (kg/12') : 3.150</p>	<p>TWO TRACK</p> <p>Premium Type Section Number : V-2702 Weight (kg/12') : 2.750</p>	<p>THREE TRACK</p> <p>Premium Type Section Number : V-2711 Weight (kg/12') : 5.000</p>
<p>THREE TRACK</p> <p>Premium Type Section Number : V-2712 Weight (kg/12') : 4.400</p>	<p>THREE TRACK</p> <p>Premium Type Section Number : V-2720 Weight (kg/12') : 6.588</p>	
<p>ADDITIONAL TRACK</p> <p>Premium Type Section Number : V-2719 Weight (kg/12') : 2.049</p>	<p>SHUTTER</p> <p>Single Glass Basic Shutter Section Number : V-2721 Weight (kg/12') : 3.050</p>	<p>SHUTTER</p> <p>Single Glass Basic Shutter Section Number : V-2722 Weight (kg/12') : 2.540</p>
<p>SHUTTER</p> <p>Single Glass Premium Shutter Section Number : V-2723/L-6 Weight (kg/12') : 3.980</p>	<p>SHUTTER</p> <p>18mm Glass Shutter Section Number : V-2724 Weight (kg/12') : 2.970</p>	<p>SHUTTER</p> <p>18mm Glass Shutter Section Number : V-2724/L Weight (kg/12') : 2.693</p>

<p>SHUTTER</p> <p>18mm Laminate Shutter Section Number : V-2730 Weight (kg/12') : 3.162</p>	<p>SHUTTER</p> <p>Mosquito Shutter Section Number : V-2725 Weight (kg/12') : 2.752</p>	<p>SHUTTER CLIP</p> <p>Mosquito Shutter Clip Section Number : V-2514 Weight (kg/mt) : 0.144</p>
<p>CLIP</p> <p>Universal Clip Section Number : V-2731 Weight (kg/12') : 1.000</p>	<p>INTERLOCK</p> <p>Slim Interlock Section Number : V-2732 Weight (kg/12') : 1.900</p>	<p>TWO TRACK</p> <p>Regular Type Section Number : V-2703/L-4 Weight (kg/12') : 3.180</p>
<p>THREE TRACK</p> <p>Regular Type Section Number : V-2713/L-3(1) Weight (kg/12') : 4.300</p>	<p>THREE TRACK</p> <p>Regular Type Section Number : V-2715 Weight (kg/12') : 4.000</p>	<p>THREE TRACK</p> <p>Regular Type Section Number : V-2714/L-3(2) Weight (kg/12') : 4.400</p>
<p>THREE TRACK</p> <p>Regular Type Section Number : V-2718 Weight (kg/12') : 4.200</p>	<p>TWO TRACK</p> <p>Regular Type Section Number : V-2706/1750 Weight (kg/12') : 2.700</p>	<p>THREE TRACK</p> <p>Regular Type Section Number : V-2716/1751 V-2716/1752 Weight (kg/12') : 3.650 4.900</p>

THREE TRACK

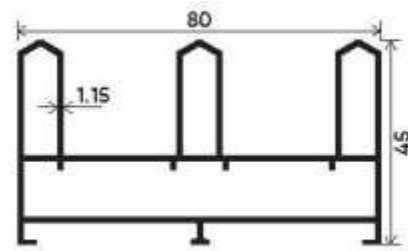

Regular Type
Section Number : V-2717
Weight (kg/12') : 4.280

SHUTTER

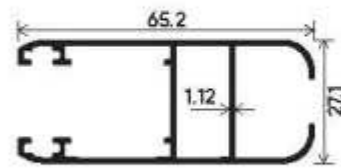

Handle Domal
Section Number : V-2726/1753 V-2726/1754
Weight (kg/12') : 2.450 2.800

SHUTTER

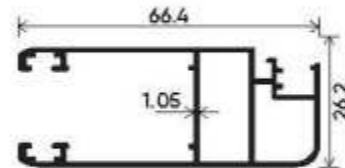

Mosquito Shutter
Section Number : V-2727/1756
Weight (kg/12') : 2.500

CLIP



Mesh Shutter Clip
Section Number : V-2728/1757
Weight (kg/12') : 0.300

MOSQUITO CLIP

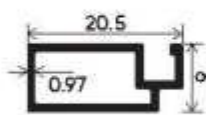

Mosquito Screen Fitting Clip
Section Number : V-2729
Weight (kg/12') : 0.550

MOSQUITO CLIP

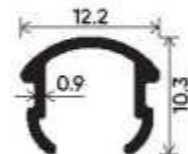

Mosquito Screen Fitting Clip
Section Number : V-2524
Weight (kg/12') : 2.900

CLIP

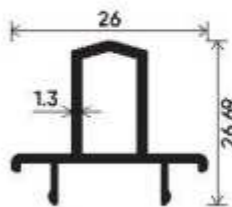

Meeting Section
Section Number : V-2743/L-2
Weight (kg/12') : 0.900

ANGLE

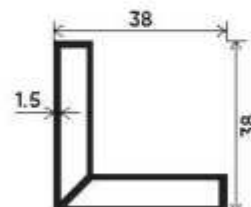

38 x 38 Angle
Section Number : V-2740
Weight (kg/12') : 2.038

SHUTTER

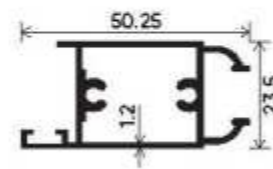

Mosquito Shutter
Section Number : V-4010/1355
Weight (kg/mt) : 0.669

THREE TRACK

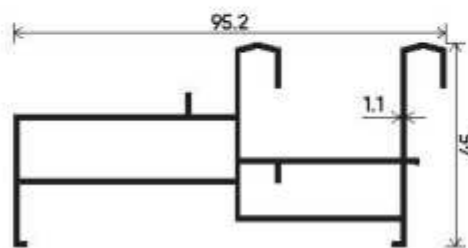

2 Track With Grill
Section Number : V-2741/1808
Weight (kg/12') : 3.500

TWO TRACK

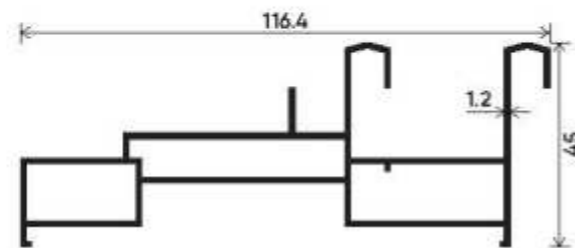

2 Track Grill With Mosquito
Section Number : V-2142/1809
Weight (kg/12') : 4.450

GRILL SUPPORT

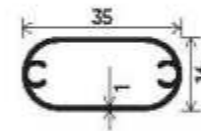

Grill Support
Section Number : V-2552
Weight (kg/mt) : 0.276

GRILL SUPPORT

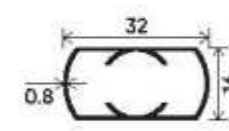

Grill Support Pipe with Safety rod
Section Number : V-2553
Weight (kg/mt) : 0.250

GRILL SUPPORT

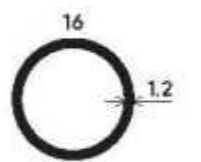

Grill Fitting Tube Cover
Section Number : V-1002
Weight (kg/mt) : 0.164



15

16

Technical Characteristics

Window Height (Max)
2700mm (Up to 9ft)

Sash Height & Width
65mm / 29mm

- Interlocking
- Slim Interlock 18mm
 - Slim Interlock 22mm
 - Slim Interlock 28mm
 - Without Slim Interlock 71mm

- Track Option
- 2Track
 - 3Track
 - 4Track

- Track Depth
- 2 Track Top/Bottom 27.3mm/72mm
 - 2 Track Vertical 13mm/76mm
 - 3 Track Top/Bottom 28mm/109mm
 - 3 Track Vertical 13mm/114mm
 - 4 Track Top/Bottom 28mm/145mm
 - 4 Track Vertical 13mm/149mm

- Corner Opening
- Possible

- Glass Range
- Single Glass Sash 5 to 8mm
 - Laminated Glass Sash 11 to 15mm
 - Double Glass Sash Upto 22mm

- Corner Joint
- Track Joint 90 Degree
 - Sash Joint 45 Degree
 - Slim Interlock 90 Degree

- Roller
- Fix Single Roller
 - Fix Double Roller
 - Adjustable Double Roller

- Locking Options
- Single Point & Multipoint

 Sound Insulation

 Wind Load

 Air Permeability

 Impact Resistance

 Water Tightness

Slim Interlock SGU

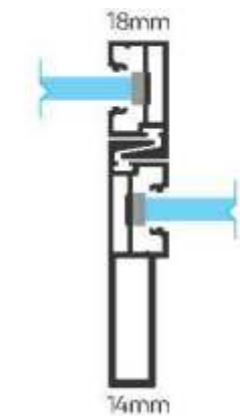

Slim Interlock DGU

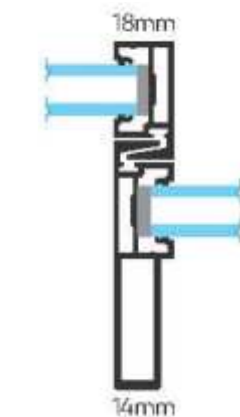

Section Detail

2 Track Top/Bottom Section No: 2940	2 Track Vertical Section No : 2941
3 Track Top/Bottom Section No: 2942	3 Track Vertical Section No: 2943
4 Track Top/Bottom Section No: 2944	4 Track Vertical Section No : 2945
Slim Interlock SGU Section No: 2961	Box Reinforcement Section No : 2962
Slim Interlock DGU Section No: 2963	Box Reinforcement DGU Section No : 2964
Locking Adapter Section No : 2543	Top Track Guide Section No: 2544
Track Rail Cap Section No: 3535	

Technical Characteristics

Window Height (Max)
2700mm (Up to 9ft)

Sash Height & Width
65mm / 29mm

- Interlocking
- Slim Interlock 18mm
 - Slim Interlock 22mm
 - Slim Interlock 28mm
 - Without Slim Interlock 71mm

- Track Option
- 2Track
 - 3Track
 - 3Track with Grill
 - 4Track

- Track Depth
- 2 Track Top/Bottom 37mm/50mm
 - 2 Track Premium 65mm/39mm
 - 3 Track Basic 36mm/86mm
 - 3 Track Premium 37mm/100mm
 - 4 Track with grill 37mm/137mm
 - 4 Track Basic 36mm/123mm

- Corner Opening
- Possible

- Glass Range
- Single Glass Sash 5 to 8mm
 - Laminated Glass Sash 11 to 15mm
 - Double Glass Sash Upto 22mm

- Corner Joint
- Track Joint 90 Degree
 - Sash Joint 45 Degree
 - Slim Interlock 90 Degree

- Roller
- Fix Single Roller
 - Fix Double Roller
 - Adjustable Double Roller

- Locking Options
- Single Point & Multipoint

 Sound Insulation

 Wind Load

 Air Permeability

 Impact Resistance

 Water Tightness



TWO TRACK

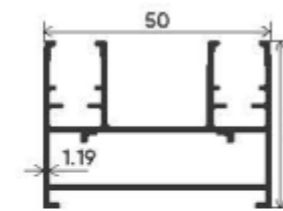

Basic Type
Section Number : V-2951
Weight (kg/mt): 0.765

THREE TRACK

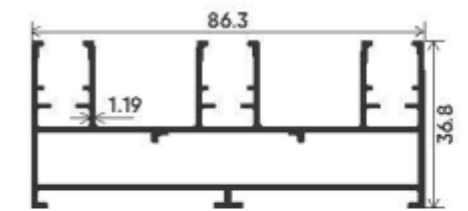

Basic Type
Section Number : V-2953
Weight (kg/mt) :1.172

TWO TRACK

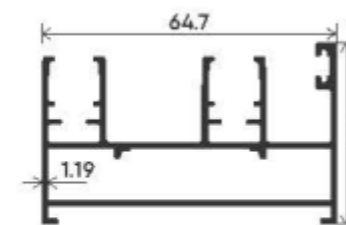

Premium Type
Section Number : V-2952
Weight (kg/mt): 0.956

THREE TRACK

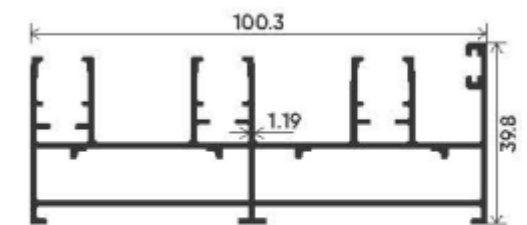

Premium Type
Section Number: V-2954
Weight (kg/mt):1.510

FOUR TRACK

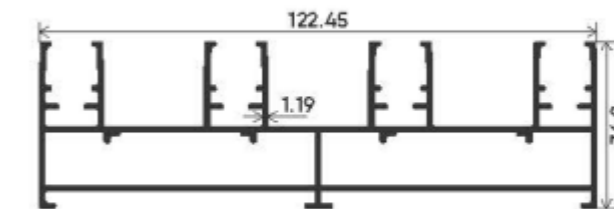

Basic Type
Section Number : V-2955
Weight (kg/mt) :1.628

THREE TRACK

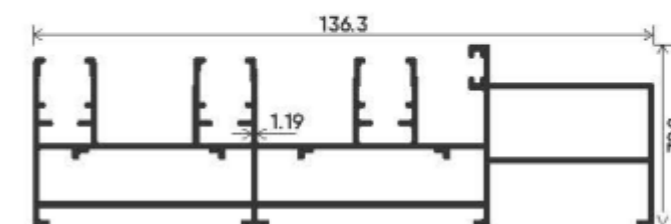

Three Track With Grill
Section Number : V-2956
Water Weight (kg/mt) :1.76



Top View

Side View

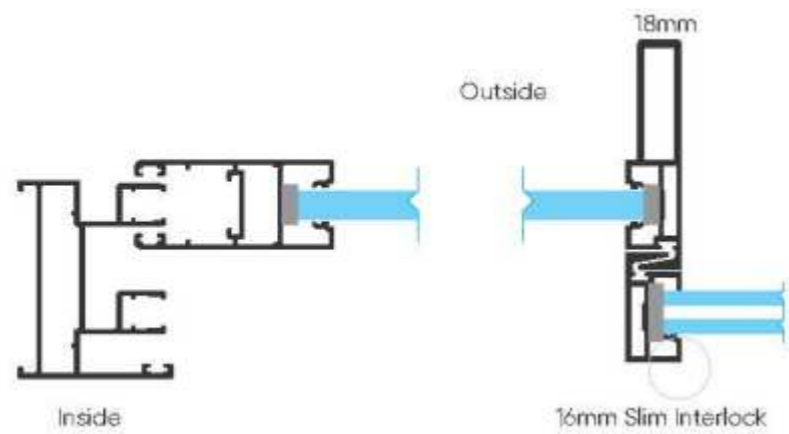

- Sound Insulation
- Wind Load
- Water Tightness
- Air Permeability
- Impact Resistance

Key feature

- European design
- Glazing from 5mm to 22mm
- Smooth & Effortless in Movement
- Automatic, Manual Concealed & Multipoint Lock System
- Provision for Insect Screen
- Reinforced Profile Available in Larger Opening
- Design for Mid to Large Size Shutter Sliding
- Bug & Bugler Proof Windows
- Slim Interlock Shutter Available for Single Glass & Double Glass Sliding

TWO TRACK

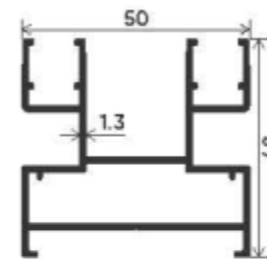

Basic Type
Section Number : V-2903/1740
Weight (kg/mt) :1.045

TWO TRACK

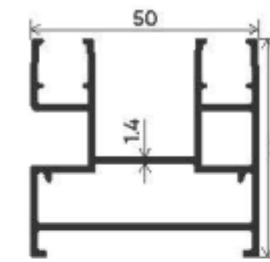

Basic Type
Section Number : V-2902
Weight (kg/mt) :1.150

TWO TRACK

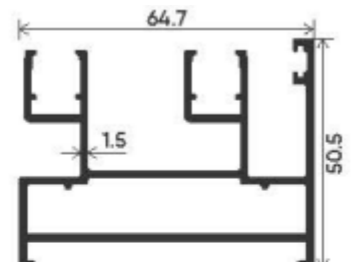

Premium Type
Section Number : V-2901
Weight (kg/mt) :1.317

THREE TRACK

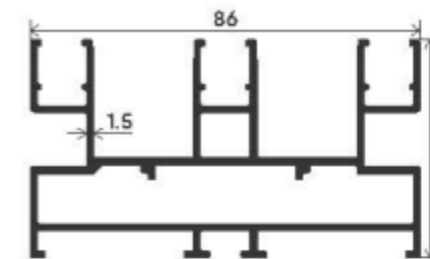

Basic Type
Section Number: V-2905/1741
Weight (kg/mt) :1.654

THREE TRACK

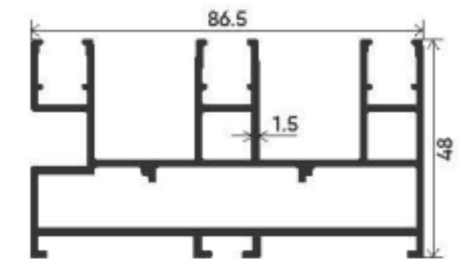

Basic Type
Section Number: V-2904
Weight (kg/mt) :1.675

THREE TRACK

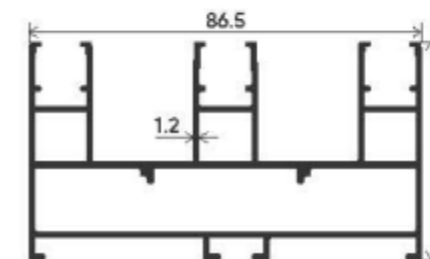

Basic Type (Both Side Plain)
Section Number : V-2910
Weight (kg/mt) :1.557

THREE TRACK

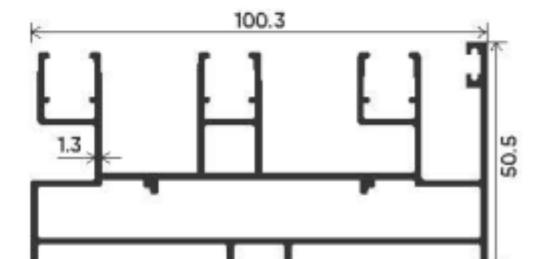

Premium Type
Section Number : V-2906
Weight (kg/mt) :1.943

THREE TRACK

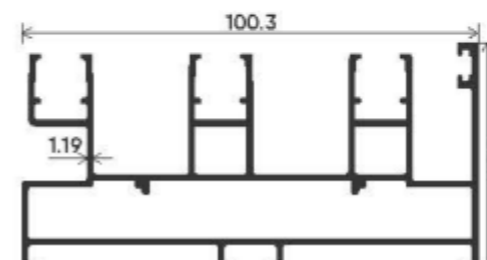

Premium Type (2 Pocket)
Section Number : V-2907
Weight (kg/mt) : 1.693

THREE TRACK

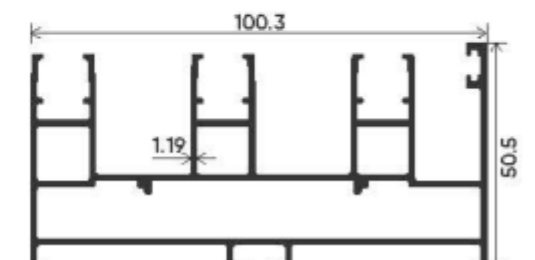

Premium Type (3 Pocket)
Section Number : V-2908
Weight (kg/mt) :1.720

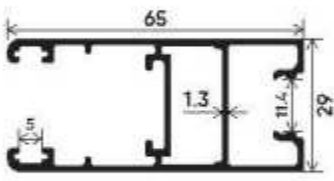
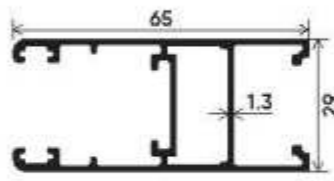
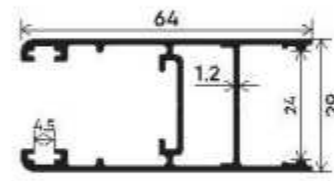
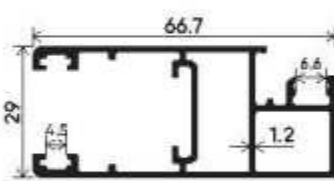
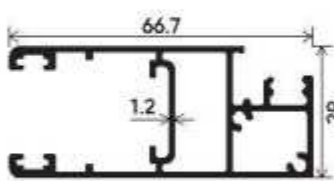
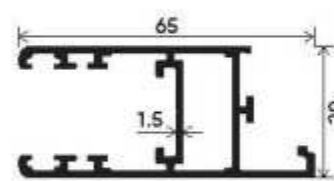
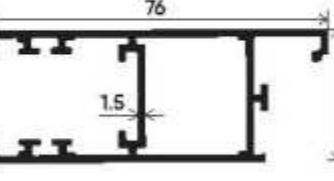
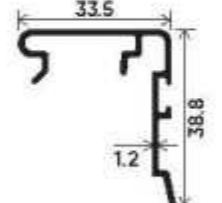
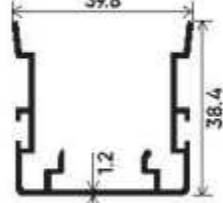
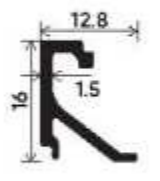
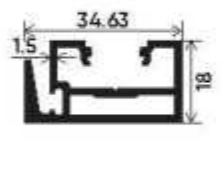
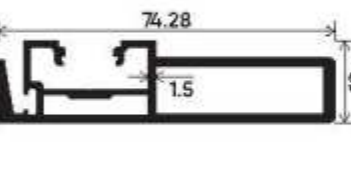
<p>SHUTTER</p>  <p>4mm-8mm Glass Shutter Section Number : V-T02/2911 Weight (kg/mt) : 0.942</p>	<p>SHUTTER</p>  <p>Laminate Shutter Section Number : V-2920 Weight (kg/mt) : 0.798</p>	<p>SHUTTER</p>  <p>5mm-22mm Glass Shutter Section Number : V-1143/2912 Weight (kg/mt) : 0.849</p>
<p>SHUTTER</p>  <p>Mosquito Screen Shutter Section Number : V-2913 Weight (kg/mt) : 0.982</p>	<p>SHUTTER</p>  <p>Mosquito Screen Shutter With Screw Section Number : V-2914 Weight (kg/mt) : 0.896</p>	<p>SHUTTER</p>  <p>Laminated Shutter With Clip Section Number : V-2915 Weight (kg/mt) : 0.962</p>
<p>SHUTTER</p>  <p>Laminated Shutter Clip Section Number : V-2916 Weight (kg/mt) : 0.134</p>	<p>INTERLOCK CLIP</p>  <p>Universal Clip Section Number : V-2921/1746 Weight (kg/mt) : 0.361</p>	<p>CLIP</p>  <p>Double Interlocking Clip Section Number : V-2922 Weight (kg/mt) : 0.473</p>
<p>CLIP</p>  <p>Laminated Shutter Clip Section Number : V-2916 Weight (kg/mt) : 0.134</p>	<p>INTERLOCK</p>  <p>Slim Interlock SGU Section Number : V-2946 Weight (kg/mt) : 0.547</p>	<p>INTERLOCK</p>  <p>Box Reinforcement Interlock SGU Section Number : V-2947 Weight (kg/mt) : 1.063</p>

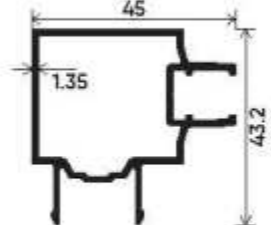
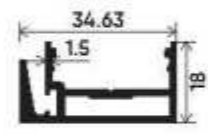
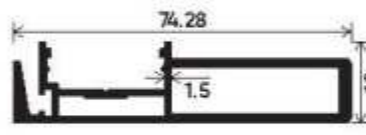
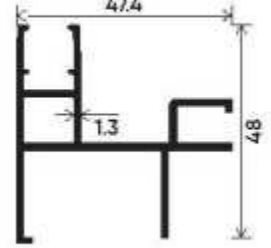
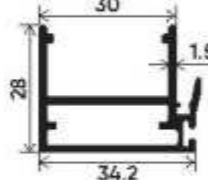
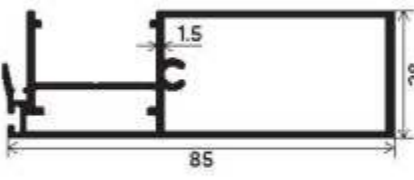
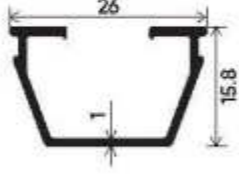
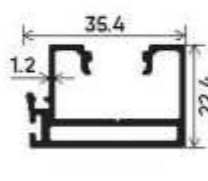
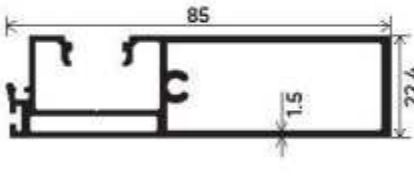
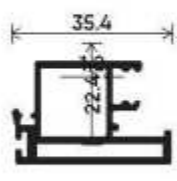
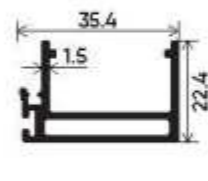
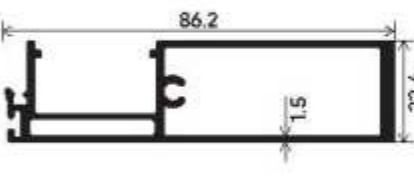
<p>SHUTTER</p>  <p>Corner Windows Shutter Section Number : V-2918 Weight (kg/mt) : 0.655</p>	<p>INTERLOCK</p>  <p>Slim Interlock DGU Section Number : V-2948 Weight (kg/mt) : 0.482</p>	<p>INTERLOCK</p>  <p>Box Reinforcement Interlock DGU Section Number : V-2949 Weight (kg/mt) : 0.976</p>
<p>ADDITIONAL TRACK</p>  <p>Additional Track Section Number : V-2909 Weight (kg/mt) : 0.700</p>	<p>SHUTTER</p>  <p>Slim Interlock Shutter 5mm-22mm Glass Shutter Section Number : V-2924 Weight (kg/mt) : 0.561</p>	<p>INTERLOCK</p>  <p>Box Reinforcement Interlock Section Number : V-2927 Weight (kg/mt) : 1.138</p>
<p>REDUCER CLIP</p>  <p>4mm-8mm Glass Section Number : V-2926 Weight (kg/mt) : 0.164</p>	<p>SHUTTER</p>  <p>Super Slim Interlock Shutter Section Number : V-2931 Weight (kg/mt) : 0.505</p>	<p>SHUTTER</p>  <p>Super Slim Box Reinforcement Interlock Section Number : V-2932 Weight (kg/mt) : 1.050</p>
<p>SHUTTER</p>  <p>Super Slim Mass Interlock Section Number : V-2933 Weight (kg/mt) : 0.505</p>	<p>INTERLOCK</p>  <p>Slim Interlock Shutter Section Number : V-2929 Weight (kg/mt) : 0.503</p>	<p>CLIP</p>  <p>Box Reinforcement Interlock Section Number : V-2930 Weight (kg/mt) : 1.044</p>

SHUTTER

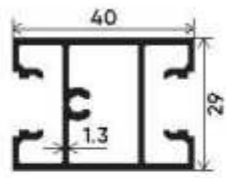

Middle Shutter
Section Number : V-2925
Weight (kg/mt) : 0.683

MIDDLE SHUTTER

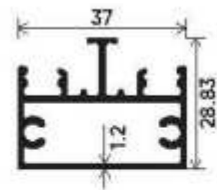

Mosquito Middle Section
Section Number : V-292B
Weight (kg/mt): 0.592

SHUTTER CLIP

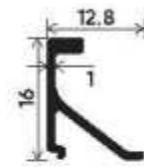

Mosquito Shutter Clip
Section Number : V-2514
Weight (kg/mt) : 0.144

GRILL SUPPORT

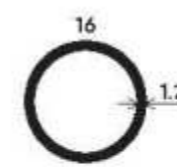

Grill Fitting Tube Cover
Section Number : V-1002
Weight (kg/mt) : 0.164

GEORGIAN BAR

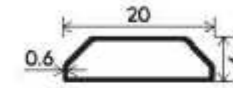

Georgian Bar
Section Number : V-2556
Weight (kg/mt) : 0.073

GEORGIAN BAR

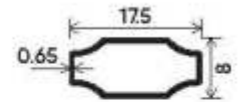

Georgian Bar
Section Number : V-2557
Weight (kg/mt) : 0.073

MEETING SECTION

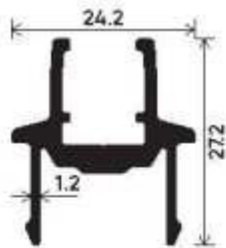

Meeting Section
Section Number : V-2935/1744
Weight (kg/12) : 0.410

TRACK RAIL CLIP

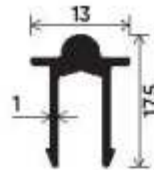

"U" Type
Section Number : V-2532
Weight (kg/mt) : 0.166

TRACK RAIL CLIP

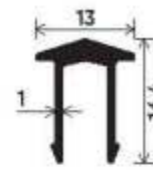

"V" Type
Section Number : V-2531
Weight (kg/mt) : 0.156

LOCKING ROD

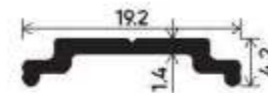

15x20 Euro Groove
Section Number : V-2551
Weight (kg/mt) : 0.156

TRACK RAIL CAP

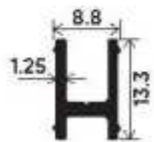

"H" Type Adapter
Section Number : V-2534
Weight (kg/mt) : 0.121

TRACK RAIL CLIP

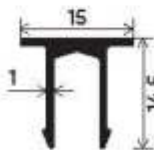

Track Cover Cap
Section Number : V-2533
Weight (kg/mt) : 0.140

MOSQUITO CLIP

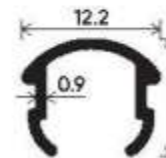

Mosquito Screen Fitting Clip
Section Number : V-2524
Weight (kg/mt) : 0.083

SHUTTER

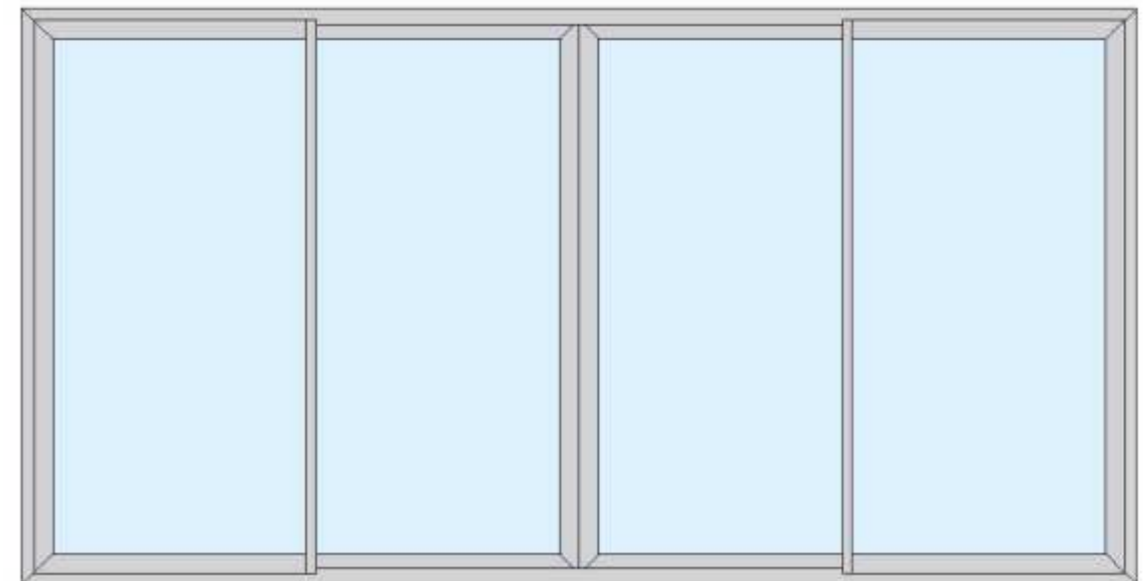

ANGLE

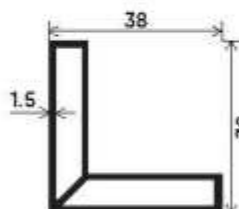

38 x 38 Angle
Section Number : V-2740
Weight (kg/12') : 2.038

GRILL SUPPORT

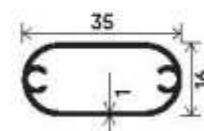

Grill Support
Section Number : V-2552
Weight (kg/mt) : 0.276

GRILL SUPPORT

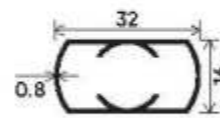

Grill Support Pipe with Safety rod
Section Number : V-2553
Weight (kg/mt) : 0.250

Technical Characteristics

Window Height (Max)
3048mm (Up to 10ft)

Sash Height & Width
59mm / 31mm
45mm / 31mm

Interlocking
• Slim Interlock 20mm

Track Option
• 2Track
• 3Track

Track Depth
• 2 Track Top/Bottom 48mm/81mm
• 2 Track Vertical 23mm/85mm
• 3 Track Top/Bottom/ 48mm/121mm
• 3 Track Vertical 23mm/125mm

Corner Opening
• Possible

Glass Range
• Single Glass Sash 5 to 8mm
• Double Glass Sash Upto 20mm

Corner Joint
• Track Joint 90 Degree
• Sash Joint 45 Degree
• Slim Interlock 90 Degree

Roller
Fix Single Roller
Fix Double Roller
Adjustable Double Roller

Locking Options
Single Point & Multipoint

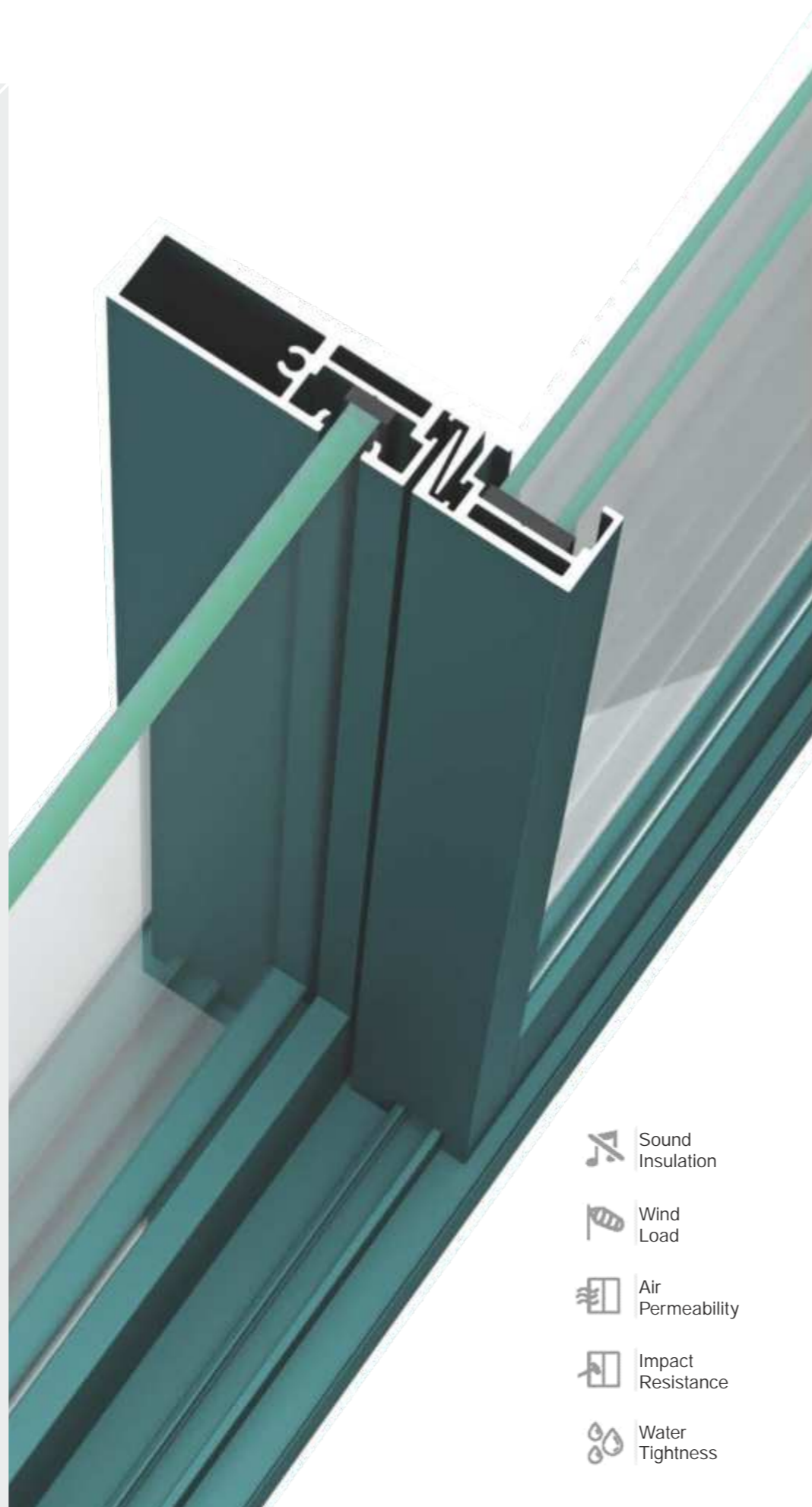

- Sound Insulation
- Wind Load
- Air Permeability
- Impact Resistance
- Water Tightness

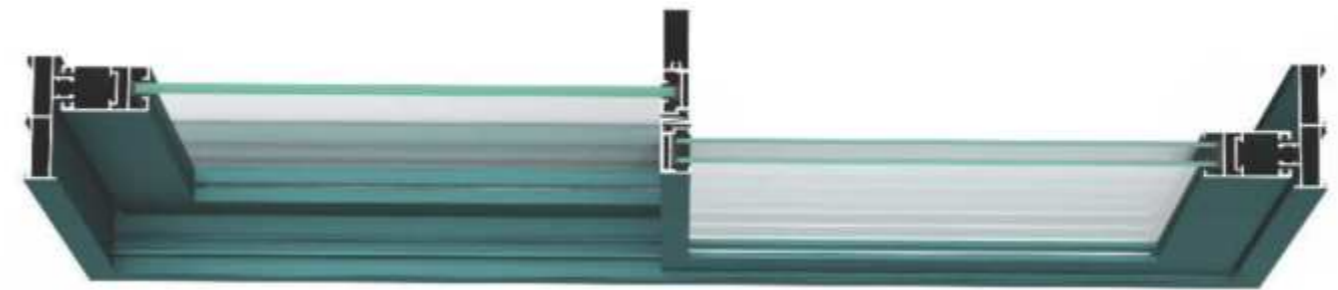

Top View

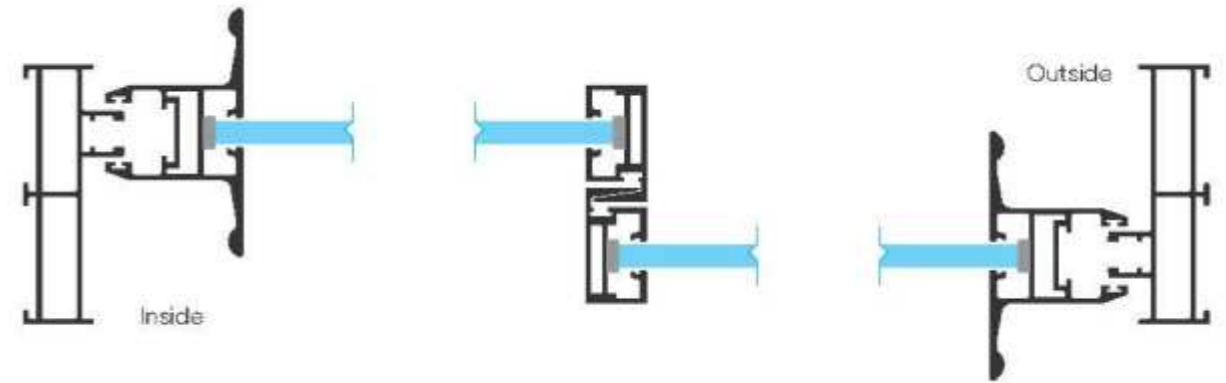

Two Track Shutter Assemble

Three Track with Mosquito

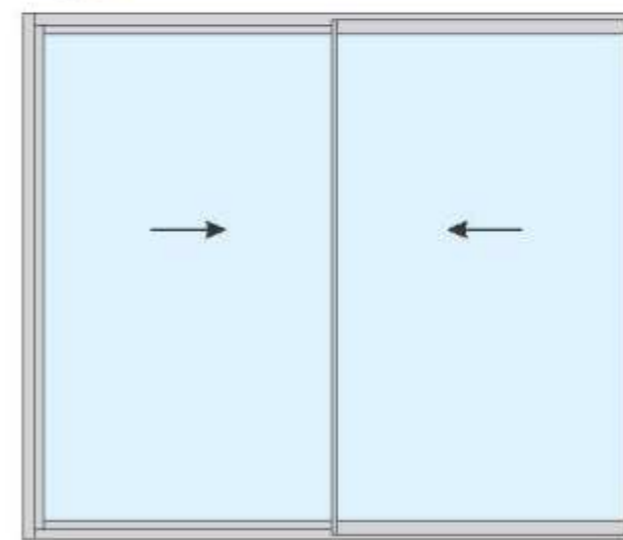

90° Shutter Cutting

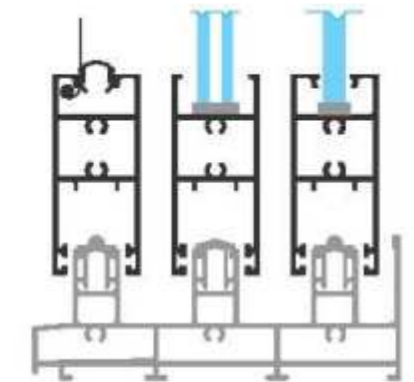

Slim Interlock SG & DGU

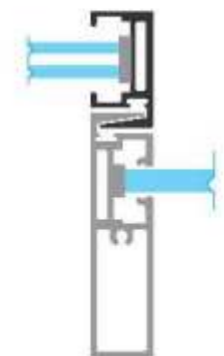

TWO TRACK

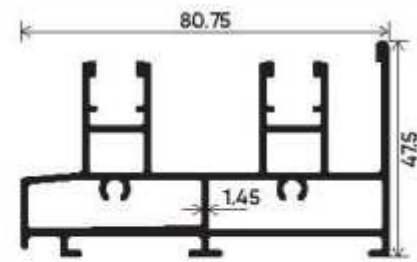

Top & Bottom Track
Section Number : V-3103
Weight (kg/m) : 1.640

TWO TRACK

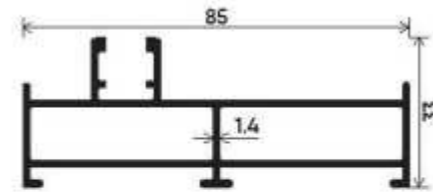

Vertical Track
Section Number : V-3102
Weight (kg/m) : 1.04

THREE TRACK

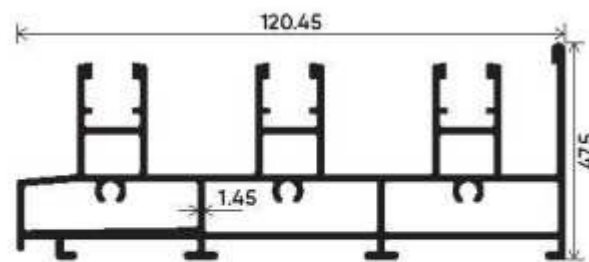

Top & Bottom Track
Section Number : V-3104
Weight (kg/m) : 2.281

THREE TRACK

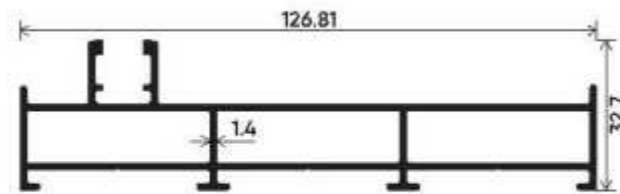

Vertical Track
Section Number : V-3105
Weight (kg/m) : 0.941

THREE TRACK

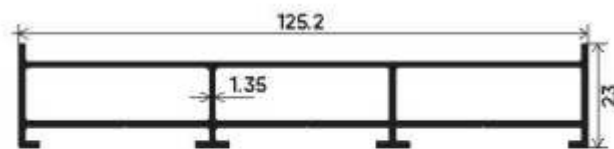

Vertical Track Plain
Section Number : V-3107
Weight (kg/m) : 1.300

ADAPTER

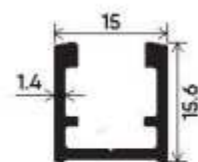

Locking Adapter
Section Number : V-3106
Weight (kg/m) : 0.199

SHUTTER

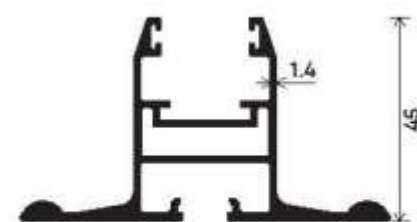

Vertical Shutter SGU
Section Number : V-3113
Weight (kg/m) : 1.100

SHUTTER

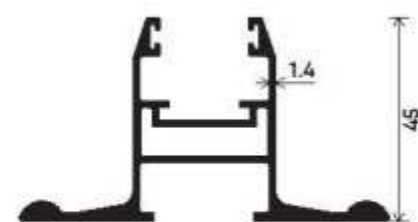

Vertical Shutter DGU
Section Number : V-3114
Weight (kg/m) : 1.168

SHUTTER

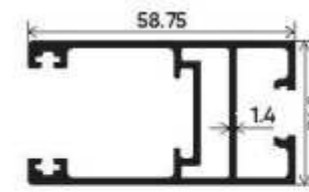

Vertical S. G. Shutter
Section Number : V-3111
Weight (kg/m) : 0.942

SHUTTER

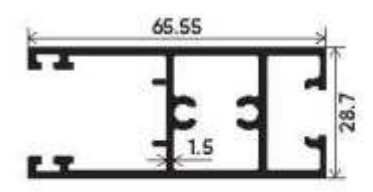

Top & Bottom S. G. Shutter
Section Number : V-3112
Weight (kg/m) : 1.079

INTERLOCK

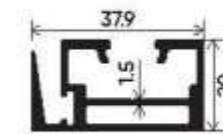

Slim Interlock S. G.
Section Number : V-3121
Weight (kg/m) : 0.683

INTERLOCK

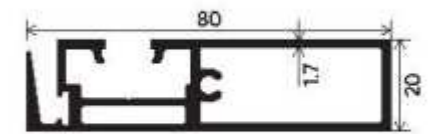

Box Reinforcement Interlock S. G.
Section Number : V-3122
Weight (kg/m) : 1.202

SHUTTER

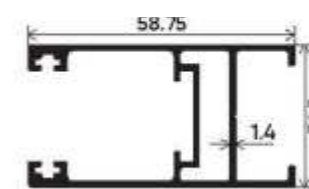

Vertical DGU Shutter
Section Number : V-3115
Weight (kg/m) : 0.942

SHUTTER

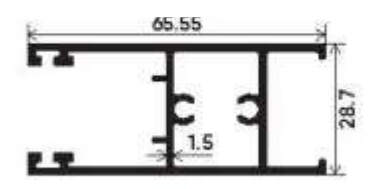

Top & Bottom DGU Shutter
Section Number : V-3116
Weight (kg/m) : 1.079

INTERLOCK

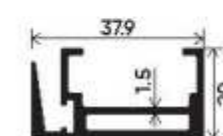

Slim Interlock DGU
Section Number : V-3117
Weight (kg/m) : 0.683

INTERLOCK

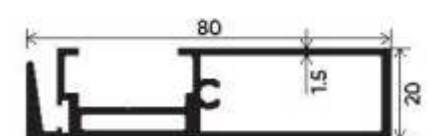

Box Reinforcement Interlock DGU
Section Number : V-3118
Weight (kg/m) : 1.202

SHUTTER

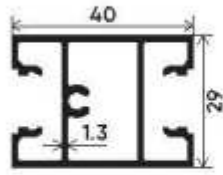

Middle Shutter
Section Number : V-2925
Weight (kg/mt) : 0.683

SHUTTER

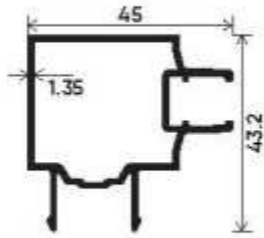

Corner Windows Shutter
Section Number : V-2918
Weight (kg/mt) : 0.655

MEETING ROOM

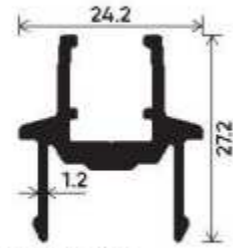

Meeting Section
Section Number : V-2935/1744
Weight (kg/12') : 0.410

TRACK RAIL CLIP

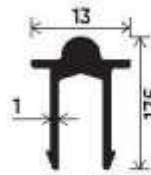

"U" Type
Section Number : V-2532
Weight (kg/mt) : 0.166

TRACK RAIL CLIP

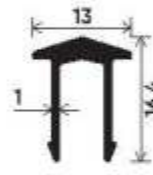

"V" Type
Section Number : V-2531
Weight (kg/mt) : 0.156

TRACK RAIL CLIP

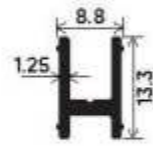

"H" Type Adapter
Section Number : V-2534
Weight (kg/mt) : 0.121

TRACK RAIL CLIP

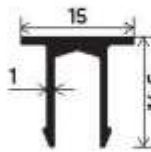

Track Cover Cap
Section Number : V-2533
Weight (kg/mt) : 0.140

MOSQUITO CLIP

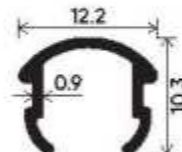

Mosquito Screen Fitting Clip
Section Number : V-2524
Weight (kg/mt) : 0.083

LOCKING ROD

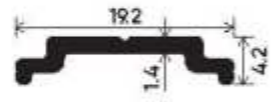

15 x 20 Euro Groove
Section Number : V-2551
Weight (kg/mt) : 0.156

GEORGIAN BAR

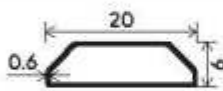

Georgian Bar
Section Number : V-2556
Weight (kg/mt) : 0.073

GEORGIAN BAR

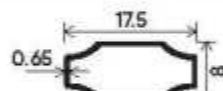

Georgian Bar
Section Number : V-2557
Weight (kg/mt) : 0.073



Technical Characteristics

Window Height (Max)
3048mm (Up to 10ft)

Sash Height & Width
51mm / 32mm
65mm / 32mm

Interlocking
• Slim Interlock 30mm
• Without Slim Interlock 71mm

Track Option
• 2Track
• 3Track

Track Depth
• 2 Track Top/Bottom 27mm/81mm
• 2 Track Vertical 13mm/84mm
• 3 Track Top/Bottom 27mm/122mm
• 3 Track Vertical 13mm/126mm

Corner Opening
• Possible

Glass Range
• Single Glass Sash 5 to 8mm
• Laminated Glass Sash 11 to 15mm
• Double Glass Sash Upto 22mm

Corner Joint
• Track Joint 90 Degree
• Sash Joint 90 Degree
• Slim Interlock 90 Degree

Roller
Fix Single Roller
Fix Double Roller
Adjustable Double Roller

Locking Options
Single Point & Multipoint

 Sound Insulation

 Wind Load

 Air Permeability

 Impact Resistance

 Water Tightness

Section Detail

2 Track Top/Bottom
Section No: 3241

2 Track Vertical
Section No: 3242

3 Track Top/Bottom
Section No: 3243

3 Track Vertical
Section No: 3244

Gulf Shutter
Section No: 3247

Gulf Top Bottom
Section No : 3248

Gulf Reducer Clip 18mm
Section No: 3249





Gulf Reducer Clip 11mm
Section No: 3250

Locking Adapter
Section No: 2543

Top Track Guide
Section No: 2544

Track Rail Cap
Section No: 3535



-  Sound Insulation
-  Wind Load
-  Air Permeability
-  Impact Resistance
-  Water Tightness

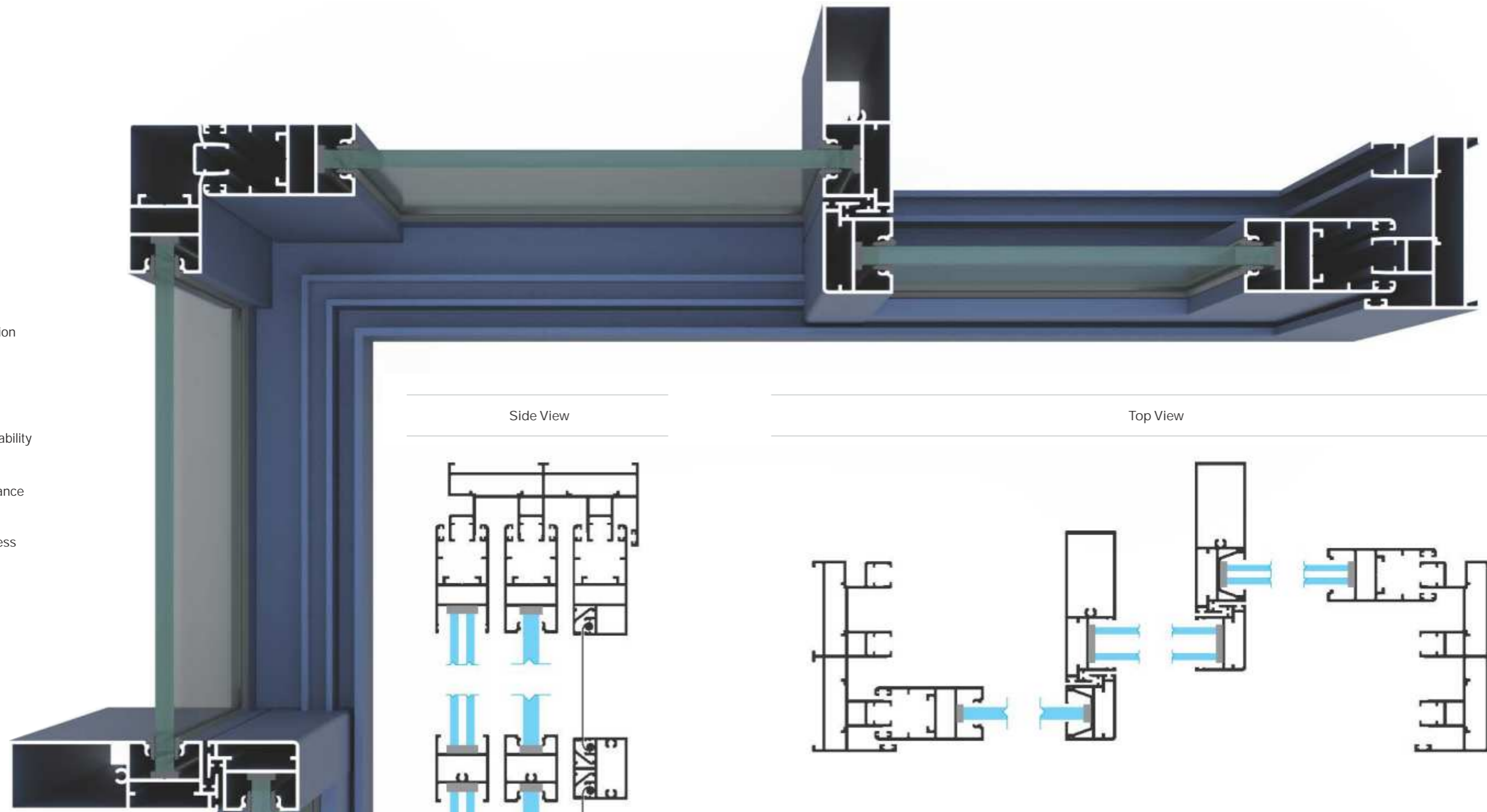

Side View

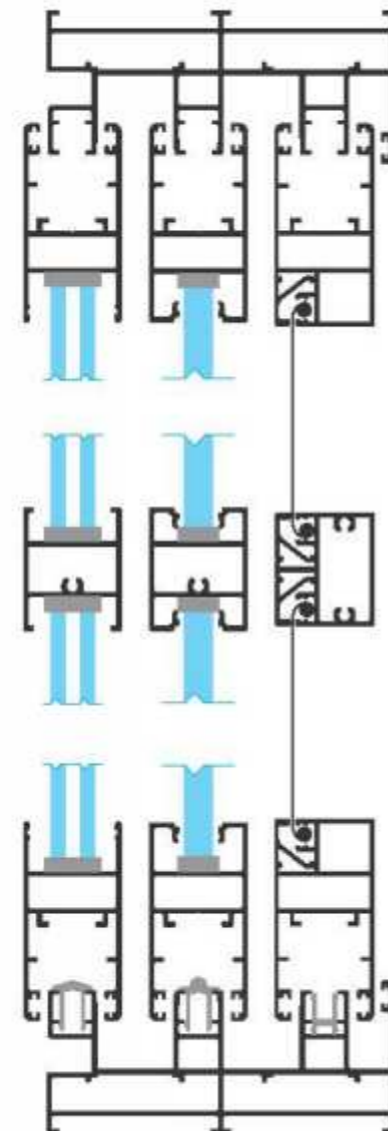

Top View

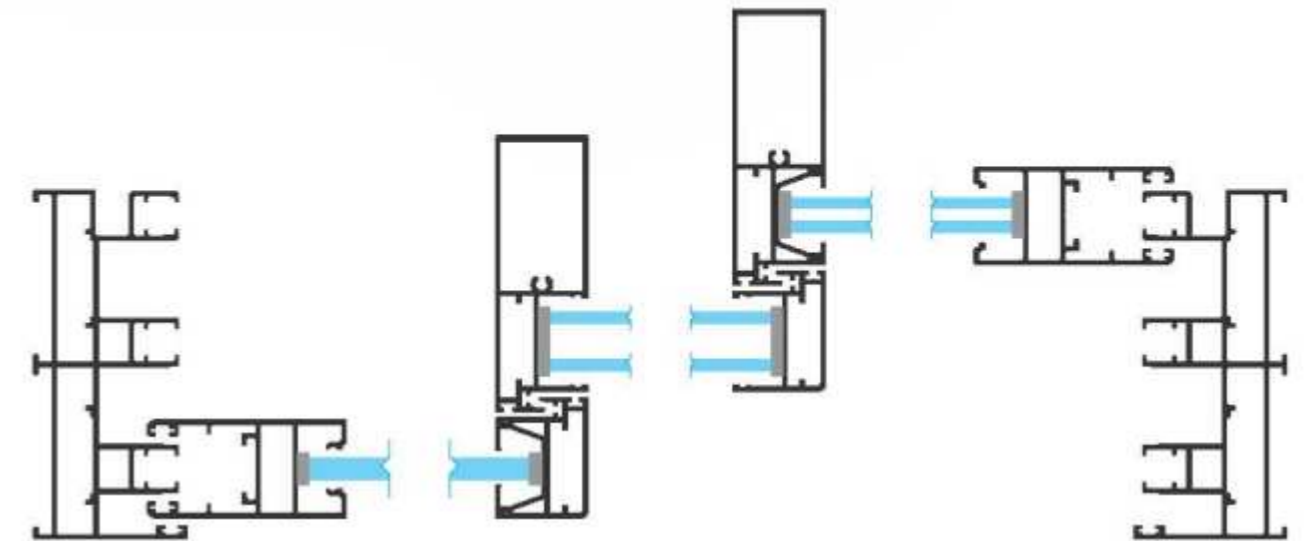

Key feature

- European design
- Glazing from 5mm to 22mm
- Smooth & Effortless in Movement
- Automatic, Manual Concealed & Multipoint Lock System
- Provision for Insect Screen
- Reinforced Profile Available in Larger Opening
- Design for Mid to Large Size Shutter Sliding
- Bug & Bugler Proof Windows
- Slim Interlock Shutter Available for Single Glass & Double Glass Sliding

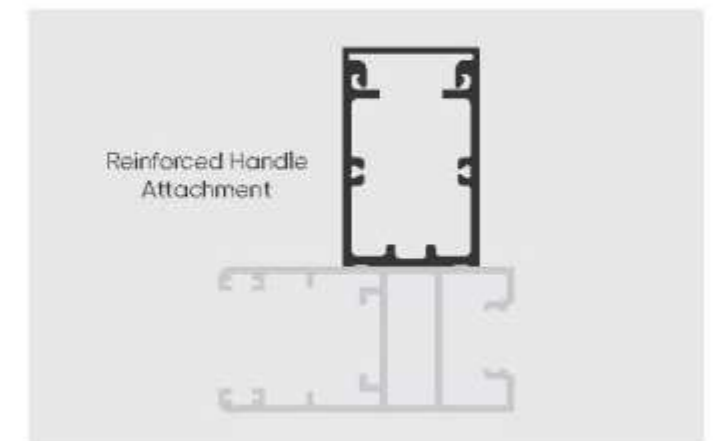
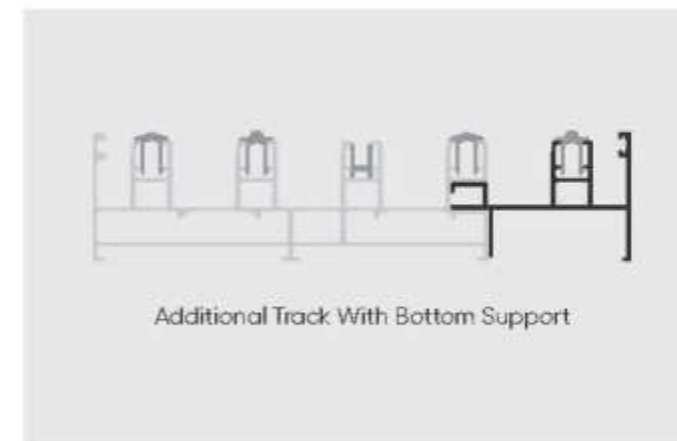

TWO TRACK

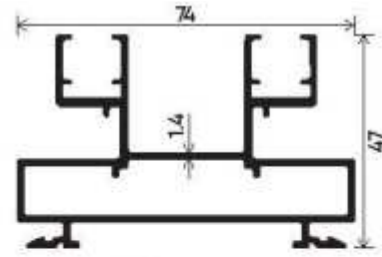

Basic Type
Section Number : V-3201
Weight (kg/mt) : 1.444

THREE TRACK

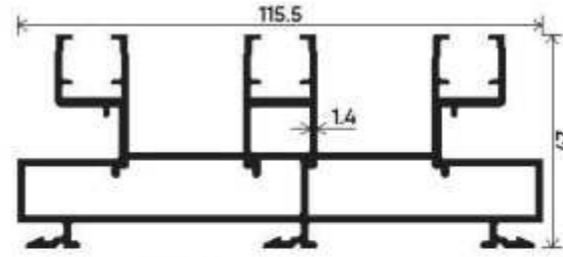

Basic Type
Section Number : V-3202
Weight (kg/mt) : 2.206

TWO TRACK

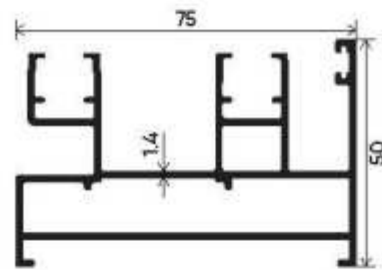

Premium Type
Section Number : V-3203
Weight (kg/mt) : 1.409

THREE TRACK

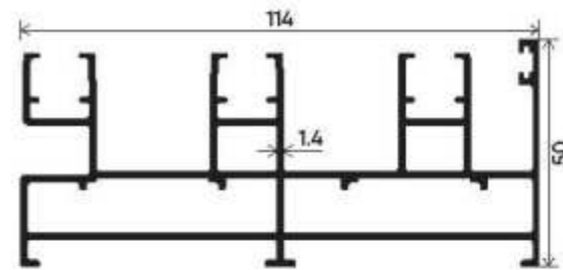

Premium Type
Section Number : V-3204
Weight (kg/mt) : 2.099

THREE TRACK

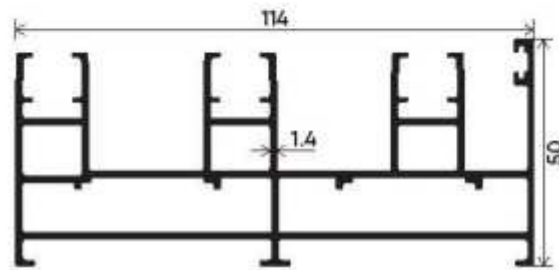

Premium Type Plain
Section Number : V-3207
Weight (kg/mt) : 2.100

Additional Track

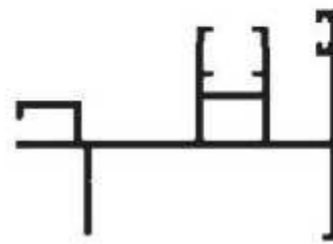

Additional Track
Section Number : V-3206
Weight (kg/mt) : 0.689

SHUTTER

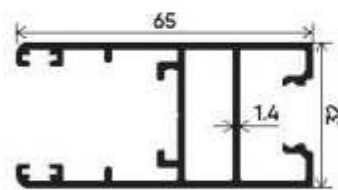

4mm-8mm Glass Shutter
Section Number : V-3211
Weight (kg/mt) : 0.950

SHUTTER

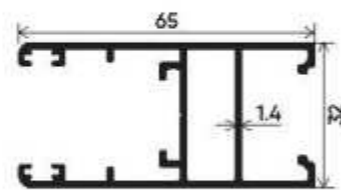

Laminate Shutter
Section Number : V-3220
Weight (kg/mt) : 0.910

SHUTTER

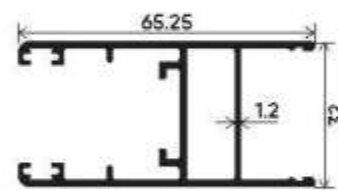

5mm-24mm Glass Shutter
Section Number : V-3212
Weight (kg/mt) : 0.947

SHUTTER

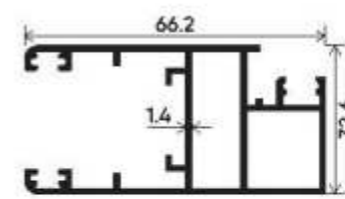

Mosquito Screen Shutter
Section Number : V-3213
Weight (kg/mt) : 0.894

SHUTTER

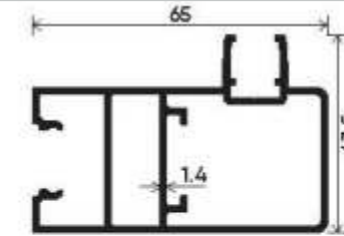

Corner Shutter
Section Number : V-3217
Weight (kg/mt) : 1.095

INTERLOCK CLIP

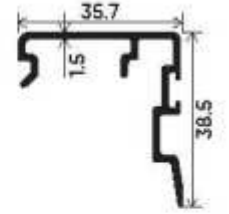

Universal Clip
Section Number : V-3221
Weight (kg/mt) : 0.561

INTERLOCK

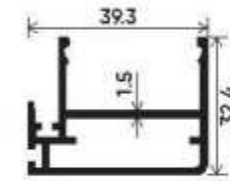

Slim Interlock Shutter
5mm-22mm Glass Shutter
Section Number : V-3223
Weight (kg/mt) : 0.596

INTERLOCK

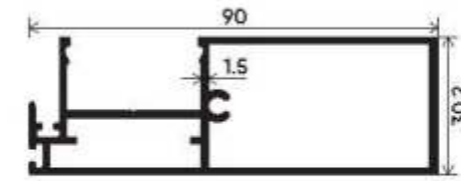

Box Reinforcement Interlock
Section Number : V-3227
Weight (kg/mt) : 1.206

INTERLOCK

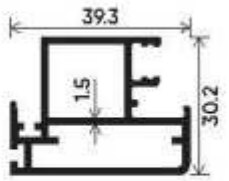

Mosquito Slim Interlock Shutter
Section Number : V-3216
Weight (kg/mt) : 0.727

INTERLOCK

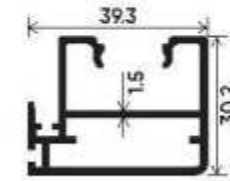

Slim Interlock Shutter SGU
Section Number : V-3224
Weight (kg/mt) : 0.692

INTERLOCK

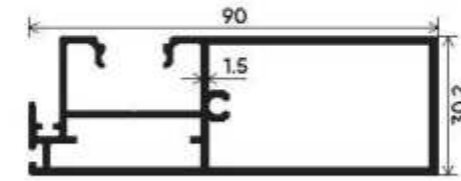

Box Reinforcement Interlock SGU
Section Number : V-3228
Weight (kg/mt) : 1.292

SHUTTER CLIP

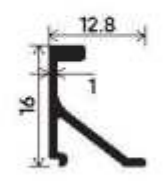

Mosquito Shutter Clip
Section Number : V-2514
Weight (kg/mt) : 0.144

REDUCER CLIP

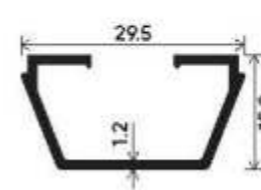

Reducer Clip SGU
Section Number : V-3226-1
Weight (kg/mt) : 0.225

REDUCER CLIP

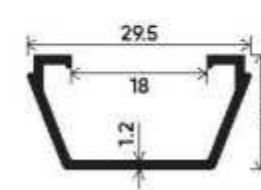

Reducer Clip Laminated
Section Number : V-3229
Weight (kg/mt) : 0.195

Meeting Section

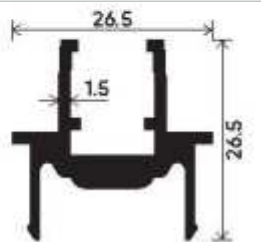

Center Opening Meeting Section
Section Number : V-3225
Weight (kg/mt) : 0.464

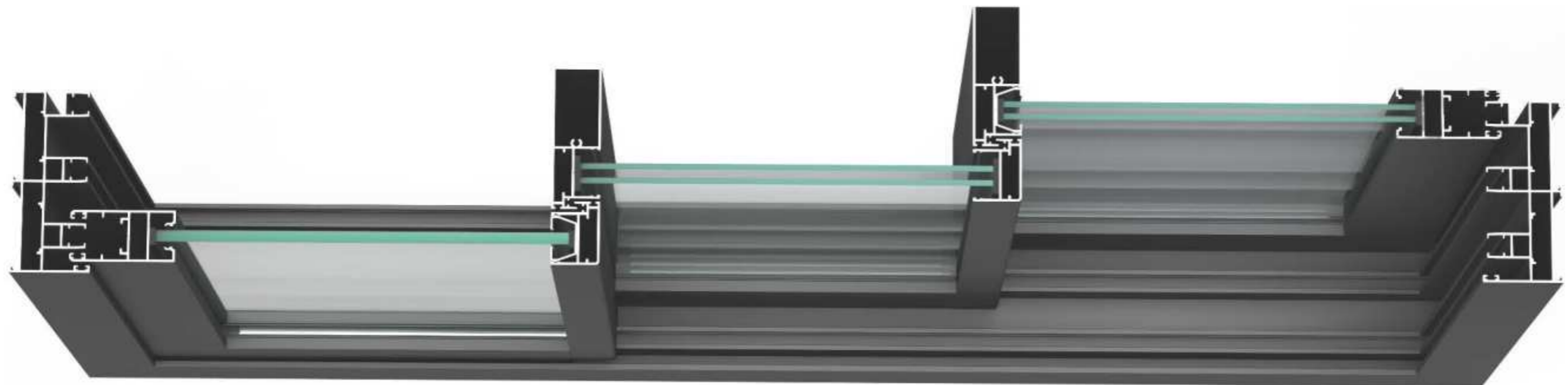

MIDDLE SECTION

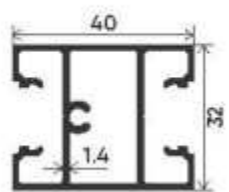

Single Glass Middle
Section Number : V-3214
Weight (kg/mt) : 0.749

MIDDLE SECTION

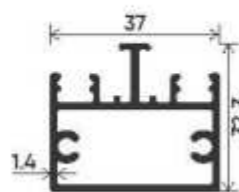

Mosquito Middle
Section Number : V-3215
Weight(kg/mt) : 0.670

MOSQUITO CLIP

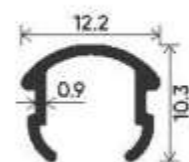

Mosquito Screen Fitting Clip
Section Number : V-2524
Weight (kg/mt) : 0.083

TRACK RAIL CLIP

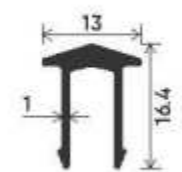

"V" Type
Section Number : V-2531
Weight(kg/mt) : 0.156

TRACK RAIL CLIP

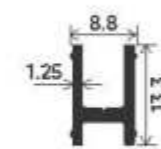

"H" Type Adapter
Section Number : V-2534
Weight (kg/mt):0.121

TRACK RAIL CLIP

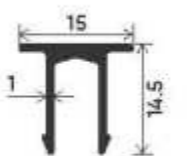

Track Cover Cap
Section Number : V-2533
Weight Cover (kg/mt) : 0.140

REINFORCEMENT

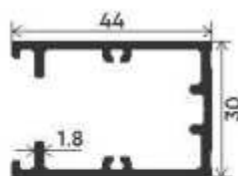

Additional Reinforcement
Section Number : V-3231
Weight (kg/mt) : 0.719

REINFORCEMENT COVER

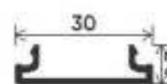

Additional Reinforcement Cover
Section Number : V-3232
Weight (kg/mt) : 0.169

TRACK RAIL CLIP

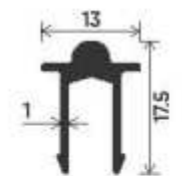

"U" Type
Section Number : V-2532
Weight (kg/mt) : 0.166

GEORGIAN BAR

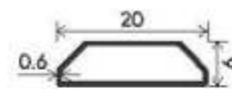

Georgian Bar
Section Number : V-2556
Weight (kg/mt) : 0.073

GEORGIAN BAR

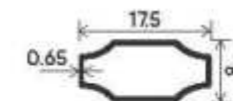

Georgian Bar
Section Number : V-2557
Weight (kg/mt) : 0.073

LOCKING ROD



15 x 20 Euro Groove
Section Number : V-2551
Weight (kg/mt) : 0.156

39

40

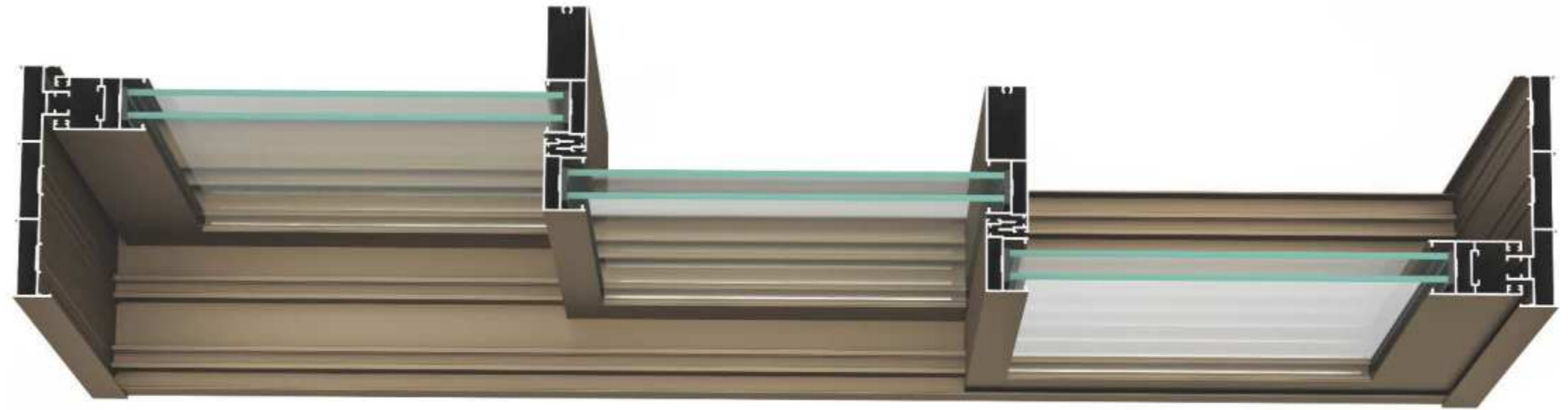

Technical Characteristics

Window Height (Max)
3048mm (Up to 10ft)
5487mm (Up to 18ft)

Sash Height & Width
59mm / 35mm

Interlocking
• Slim Interlock 27mm
• Double Interlock

Track Option
• 2Track
• 3Track

Track Depth
• 2 Track Top/Bottom 31mm/95mm
• 2 Track Vertical 23mm/100mm
• 3 Track Top/Bottom 31mm/145mm
• 3 Track Vertical 25mm/150mm

Corner Opening
• Possible

Glass Range
• Single Glass Sash 6 to 13.5mm
• Laminated Glass Sash 12 to 14mm
• Double Glass Sash Upto 24mm

Corner Joint
• Track Joint 90 Degree
• Sash Joint 90 Degree
• Slim Interlock 90 Degree

Roller
Fix Single Roller
Fix Double Roller
Adjustable Double Roller

Locking Options
Single Point & Multipoint

Sound Insulation

Wind Load

Air Permeability

Impact Resistance

Water Tightness

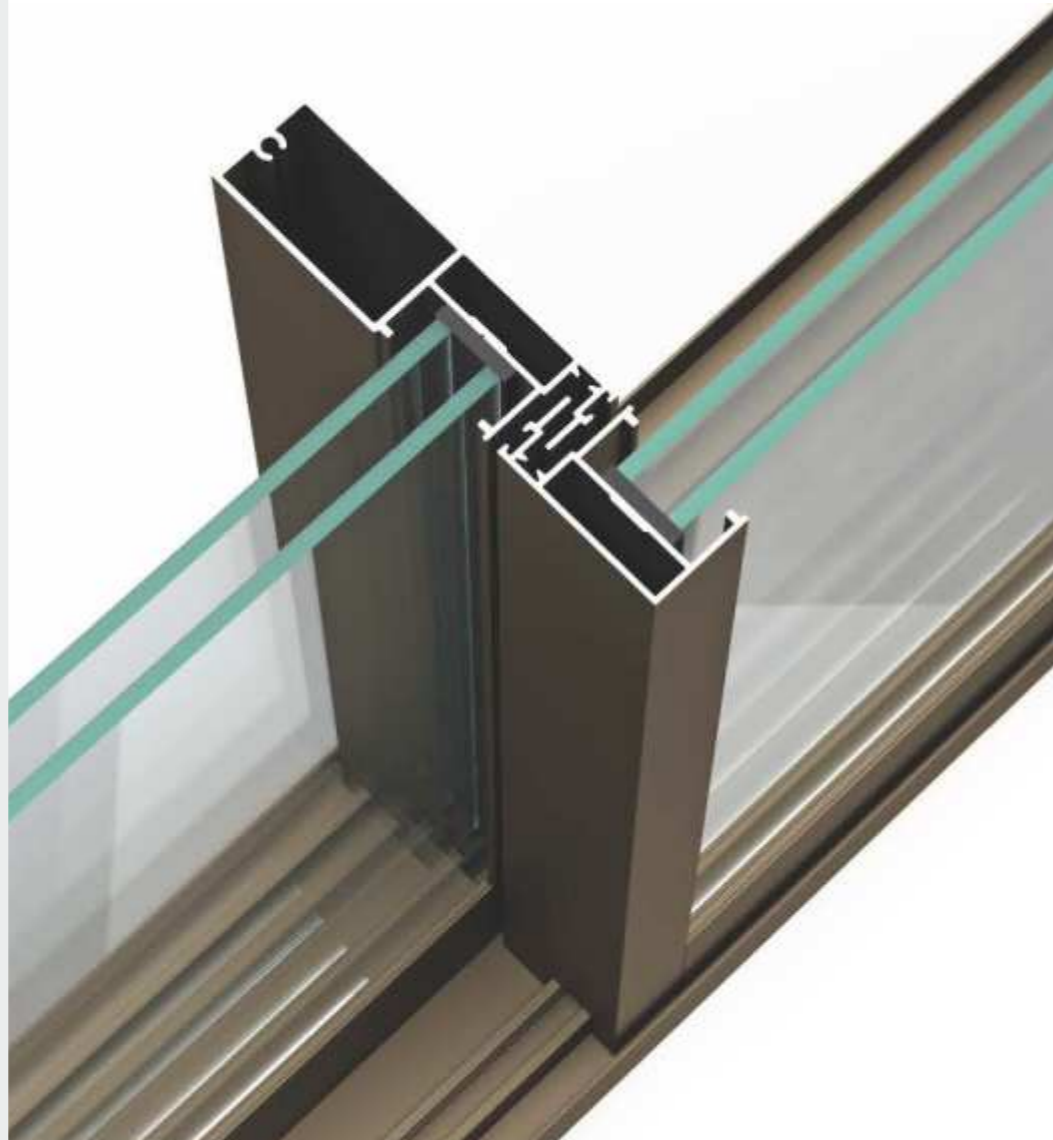

Top View

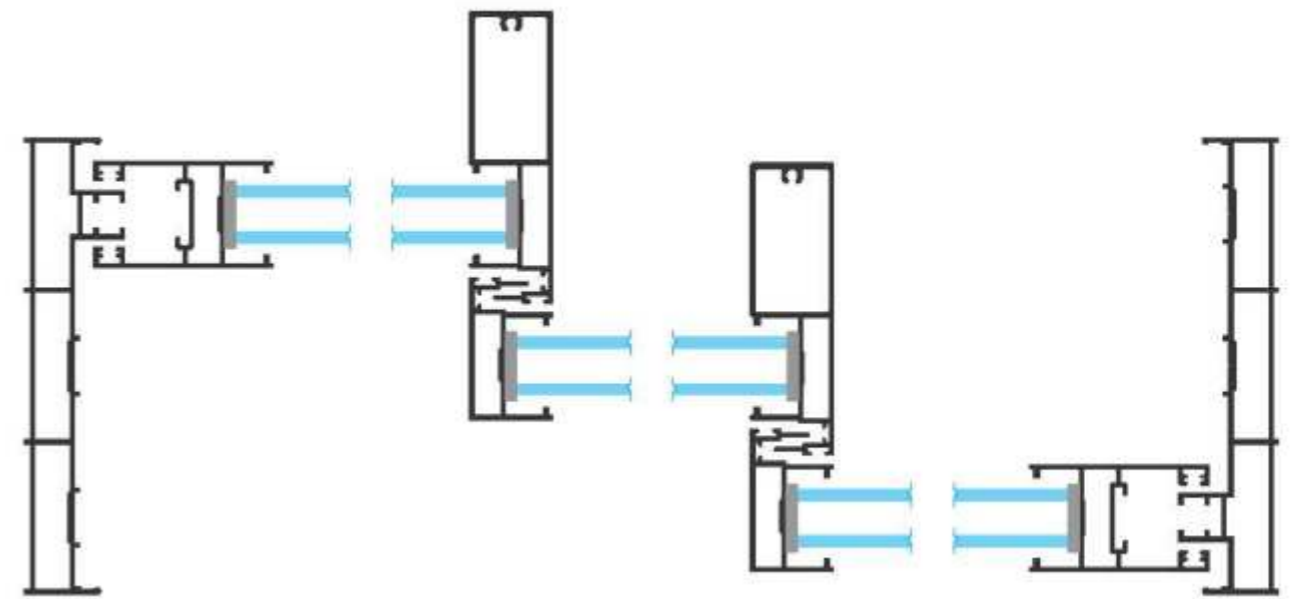

Three Track with Mosquito Assamble

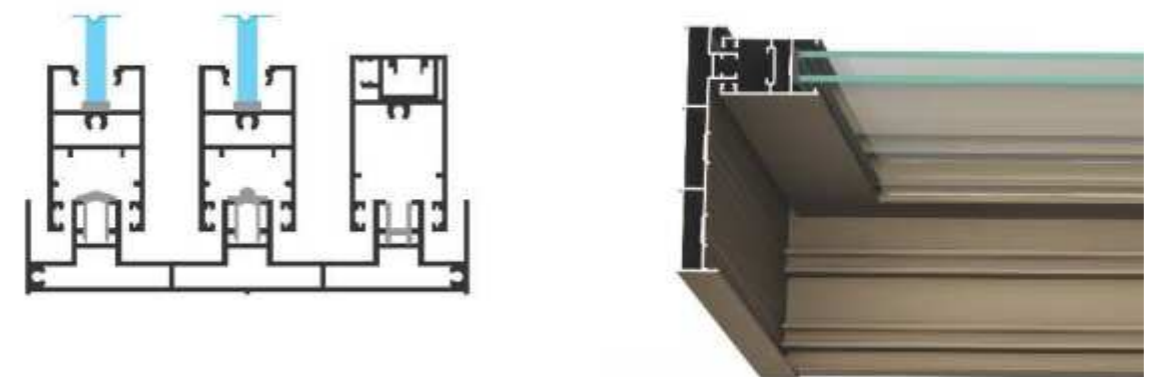

TWO TRACK SIDE

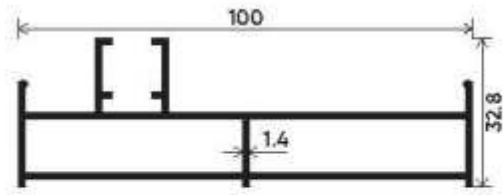

Vertical Track
Section Number : V-3501
Weight (kg/mt) : 1.134

TWO TRACK

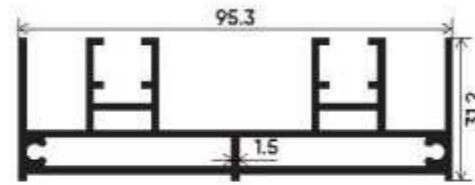

Top & Bottom Track
Section Number : V-3502
Weight (kg/mt) : 1.544

THREE TRACK SIDE

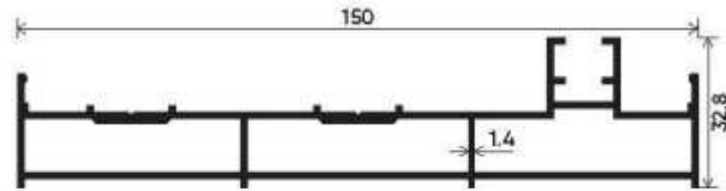

Vertical Track
Section Number : V-3503
Weight (kg/mt) : 1.566

THREE TRACK SIDE

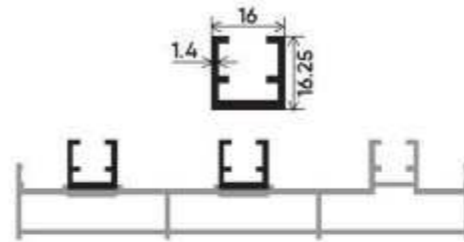

Vertical Track
Section Number : V-3504
Weight (kg/mt) : 0.245

THREE TRACK

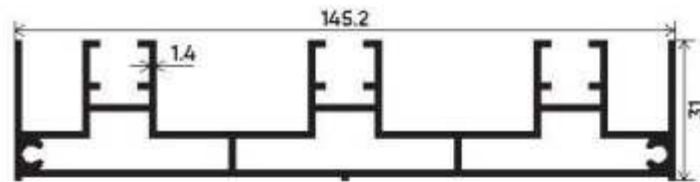

Top & Bottom Track
Section Number : V-3505
Weight (kg/mt) : 2.073

DRAINAGE TRACK

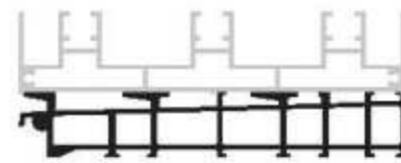

Water Drainage Track
Section Number : V-3523
Weight (kg/mt) : 2.049

THREE TRACK SIDE

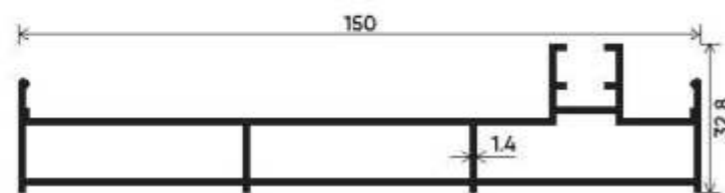

Plain Vertical Track
Section Number : V-3510
Weight (kg/mt) : 1.566

SHUTTER

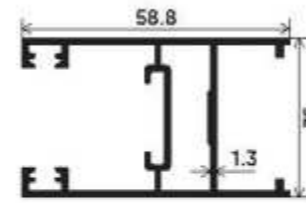

Vertical Shutter
Section Number : V-3511
Weight (kg/mt) : 0.891

SHUTTER

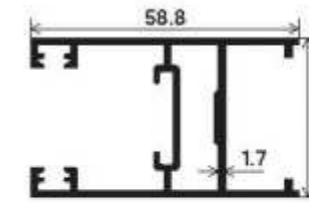

Vertical Shutter Heavy
Section Number : V-3514
Weight (kg/mt) : 0.930

SHUTTER

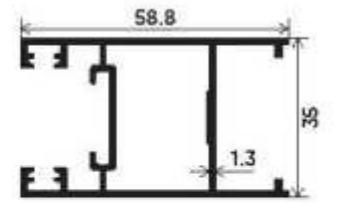

Vertical Shutter Premium
Section Number : V-3530
Weight (kg/mt) : 0.891

SHUTTER

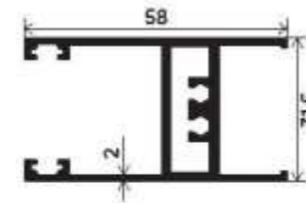

Top & Bottom Shutter Heavy
Section Number : V-3529
Weight (kg/mt) : 1.000

SHUTTER

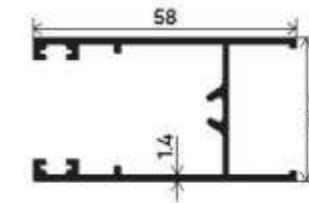

Top & Bottom Shutter
Section Number : V-3512
Weight (kg/mt) : 0.683

SHUTTER

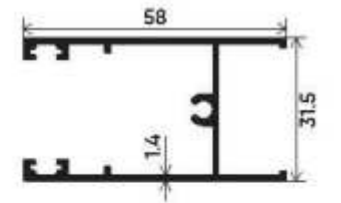

Top & Bottom Shutter
Section Number : V-3512-1
Weight (kg/mt) : 0.700

SHUTTER

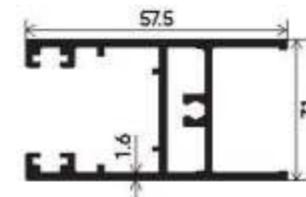

DGU Top Bottom Shutter
Section Number : V-3548
Weight (kg/mt) : 0.928

INTERLOCK

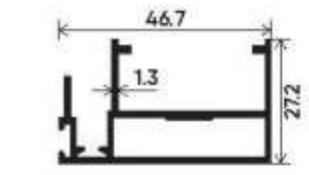

Interlock
Section Number : V-3515
Weight (kg/mt) : 0.643

INTERLOCK

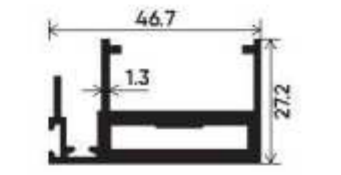

Interlock Heavy
Section Number : V-3526
Weight (kg/mt) : 0.989

INTERLOCK

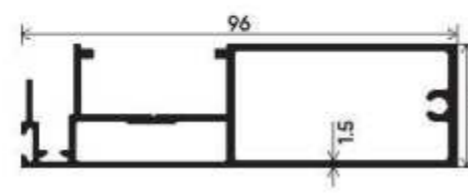

Box Reinforcement Interlock
Section Number : V-3516-1
Weight (kg/mt) : 1.179

INTERLOCK

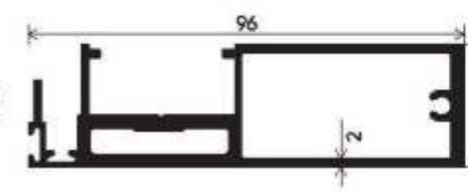

Box Reinforcement Interlock Heavy
Section Number : V-3527
Weight (kg/mt) : 1.761

SHUTTER

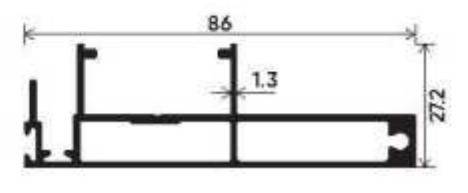

40mm Reinforcement
Interlock Shutter
Section Number : V-3517
Weight (kg/mt) : 0.977

MIDDLE SECTION

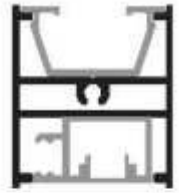

Glass/Mass Middle Section
Section Number : V-3521
Weight (kg/mt) : 0.610

REDUCER CLIP

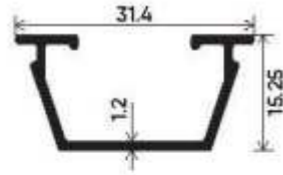

Shutter Glass Reducer Clip
Section Number : V-3522
Weight (kg/mt) : 0.211

INTERLOCK



Double Side Interlock
Section Number : V-3528
Weight (kg/mt) : 1.150

ADAPTOR

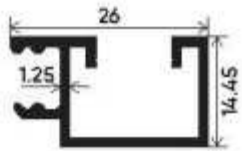

Mosquito Screen Adaptor
Section Number : V-3524
Weight (kg/mt) : 0.242

CLIP



Screw Cover Cap
Section Number : V-3525
Weight (kg/mt) : 0.047

PLAIN TRACK CAP

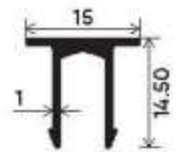

Vertical & Top Track Cover
Section Number : V-2533
Weight (kg/mt) : 0.156

TRACK RAIL CLIP

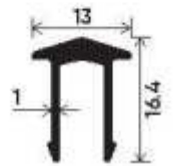

"V" Type
Section Number : V-2531
Weight (kg/mt) : 0.156

TRACK RAIL CLIP

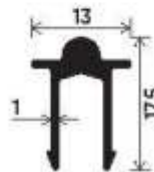

"U" Type
Section Number : V-2532
Weight (kg/mt) : 0.166

TRACK RAIL CLIP

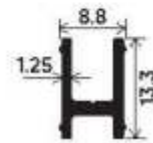

"H" Type Adapter
Section Number : V-2534
Weight (kg/mt) : 0.121

MEETING SECTION

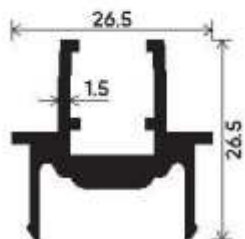

Center Opening Meeting Section
Section Number : V-3225
Weight (kg/mt) : 0.464

GEORGIAN BAR

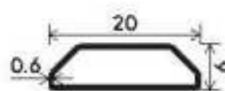

Georgian Bar
Section Number : V-2556
Weight (kg/mt) : 0.073

GEORGIAN BAR

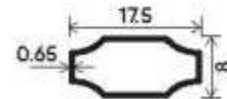

Georgian Bar
Section Number : V-2557
Weight (kg/mt) : 0.073



45

46

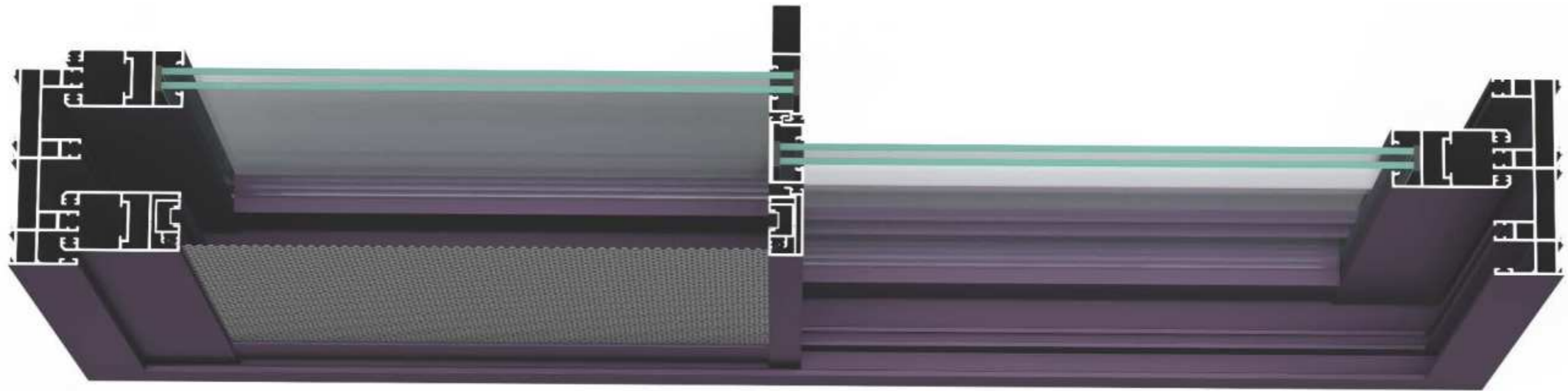

Top View

20mm Slim Interlock

Three Track with Mosquito Assemble

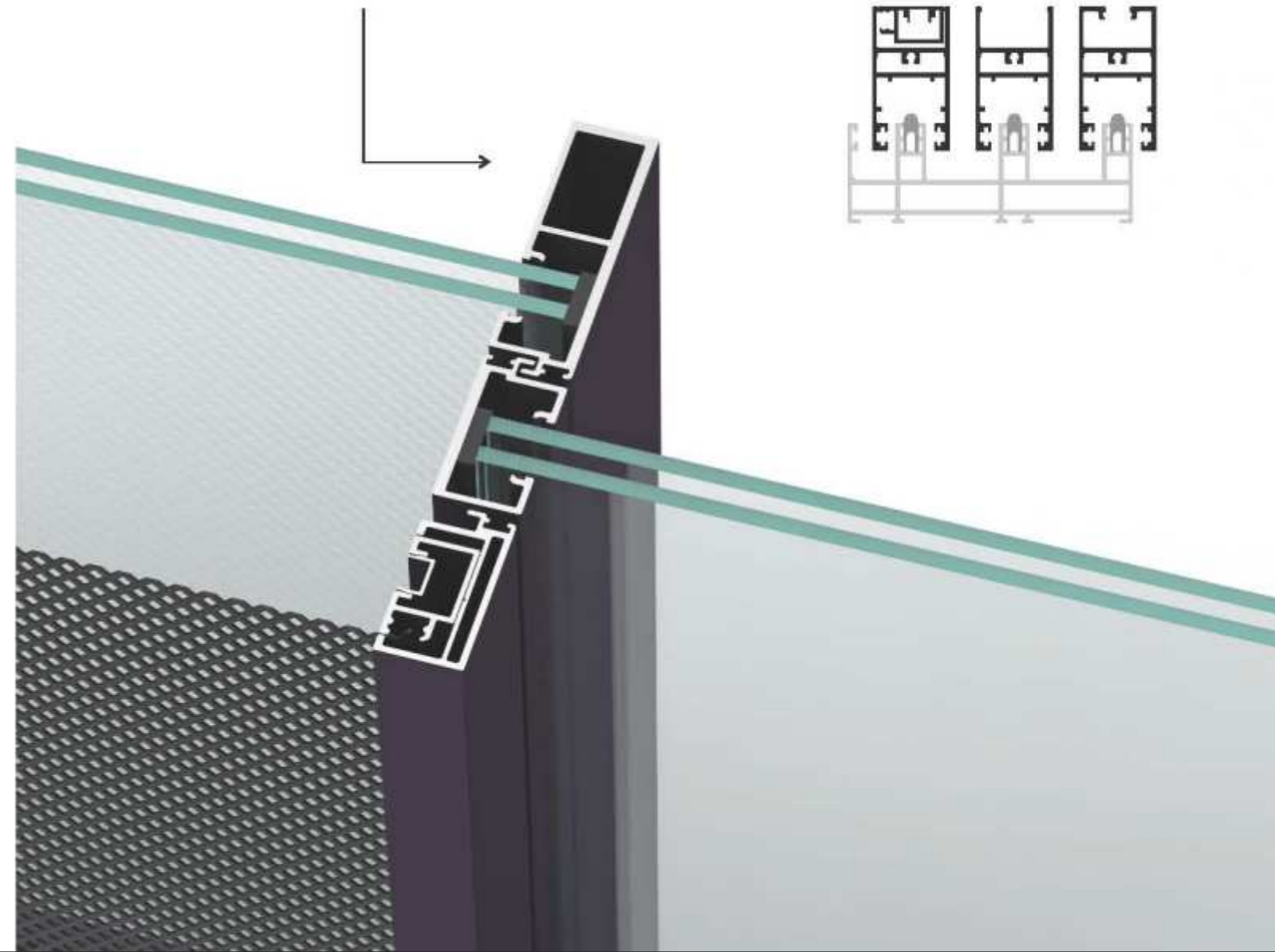
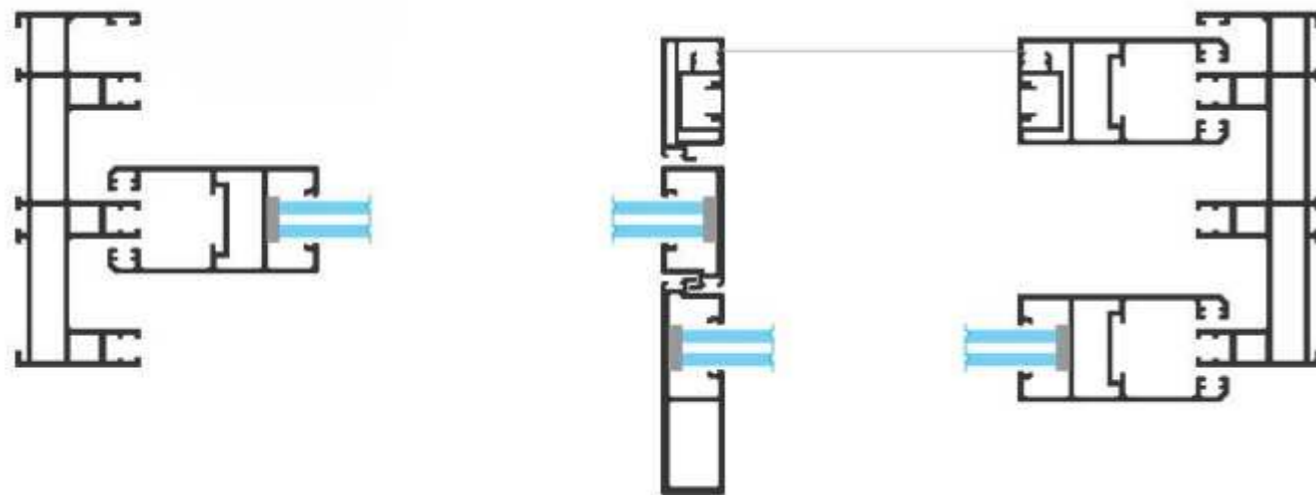

Key feature

- European design
- Glazing from 5mm to 24mm
- Smooth & Effortless in Movement
- Automatic, Manual Concealed & Multipoint Lock System
- Provision for Insect Screen
- Reinforced Profile Available in Larger Opening
- Design for Mid to Large Size Shutter Sliding
- Bug & Bugler Proof Windows
- Slim Interlock Shutter Available for Single Glass & Double Glass Sliding

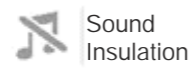

Sound Insulation



Air Permeability



Wind Load



Impact Resistance



Water Tightness

THREE TRACK

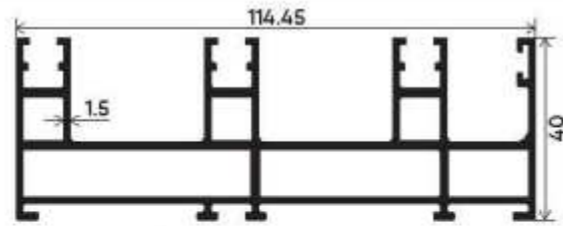

Premium Type
Section Number : V-3531
Weight (kg/mt) : 2.150

THREE TRACK

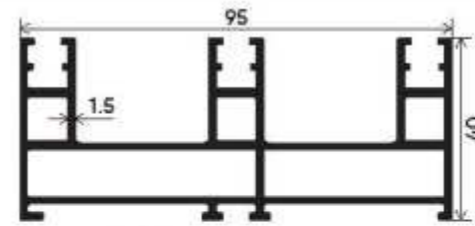

Premium Type
Section Number : V-3532
Weight (kg/mt) : 1.870

TWO TRACK

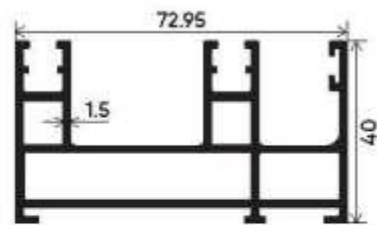

Premium Type
Section Number : V-3533
Weight (kg/mt) : 1.478

TWO TRACK

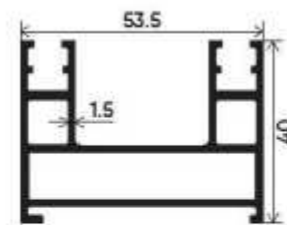

Basic Type
Section Number : V-3534
Weight (kg/mt) : 1.110

TRACK RAIL CAP



Track Rail Cap
Section Number : V-3535
Weight (kg/mt) : 0.141

SHUTTER

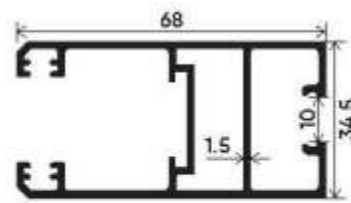

10mm Single Glass
Vertical Shutter
Section Number : V-3538
Weight (kg/mt) : 1.102

SHUTTER

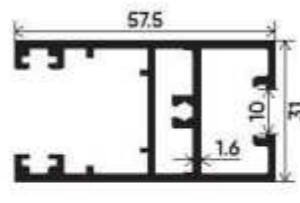

10mm Single Glass
Top Bottom Shutter
Section Number : V-3539
Weight (kg/mt) : 1.033

INTERLOCK

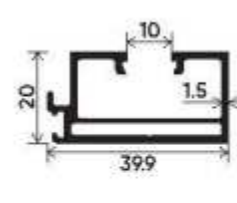

10mm Single Glass
Slim Interlock
Section Number : V-3544
Weight (kg/mt) : 0.544

INTERLOCK

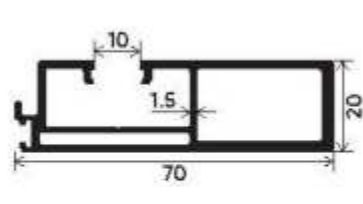

10mm Single Glass
Box Reinforcement Interlock
Section Number : V-3545
Weight (kg/mt) : 0.988

SHUTTER

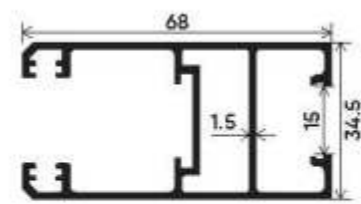

Vertical Shutter (Laminated Glass)
Section Number : V-3536
Weight (kg/mt) : 1.066

SHUTTER

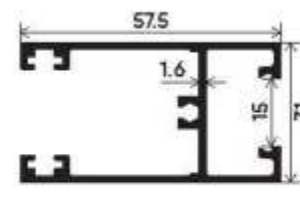

Top Bottom Shutter
(Laminated Glass)
Section Number : V-3537
Weight (kg/mt) : 0.869

INTERLOCK

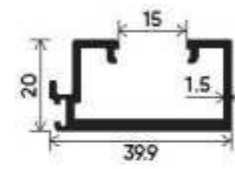

Slim Interlock Shutter
(Laminated Glass)
Section Number : V-3541
Weight (kg/mt) : 0.525

INTERLOCK

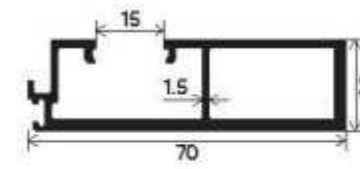

Box Reinforcement Interlock
(Laminated Glass)
Section Number : V-3542
Weight (kg/mt) : 0.961

SHUTTER

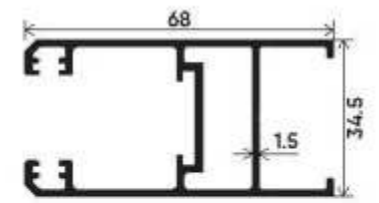

DGU Vertical Shutter
Section Number : V-3547
Weight (kg/mt) : 1.000

SHUTTER

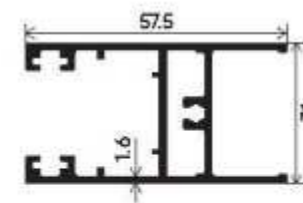

DGU Top Bottom Shutter
Section Number : V-3548
Weight (kg/mt) : 0.928

INTERLOCK

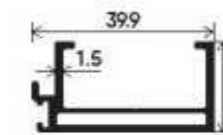

DGU Slim Interlock
Section Number : V-3549
Weight (kg/mt) : 0.450

INTERLOCK

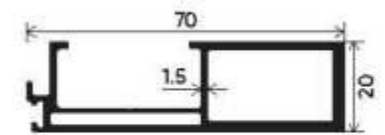

DGU Box Reinforcement Interlock
Section Number : V-3550
Weight (kg/mt) : 0.884

SHUTTER

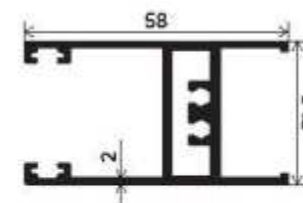

Top & Bottom Shutter Heavy
Section Number : V-3529
Weight (kg/mt) : 1.000

ADAPTOR

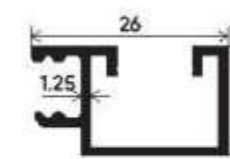

Mosquito Screen Adaptor
Section Number : V-3524
Weight (kg/mt) : 0.242

CLIP

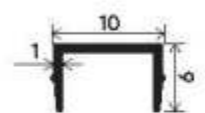

Screw Cover Cap
Section Number : V-3525
Weight (kg/mt) : 0.047

MEETING SECTION

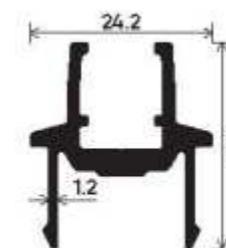

Meeting Section
Section Number : V-2935/1744
Weight (kg/12') : 0.410

MIDDLE SECTION



Glass/Mass Middle Section
Section Number : V-3521
Weight (kg/mt) : 0.610

CLIP

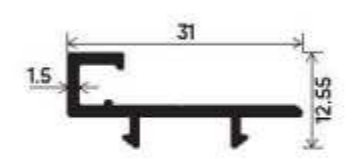

Mosquito Clip
Section Number : V-3543
Weight (kg/mt) : 0.20

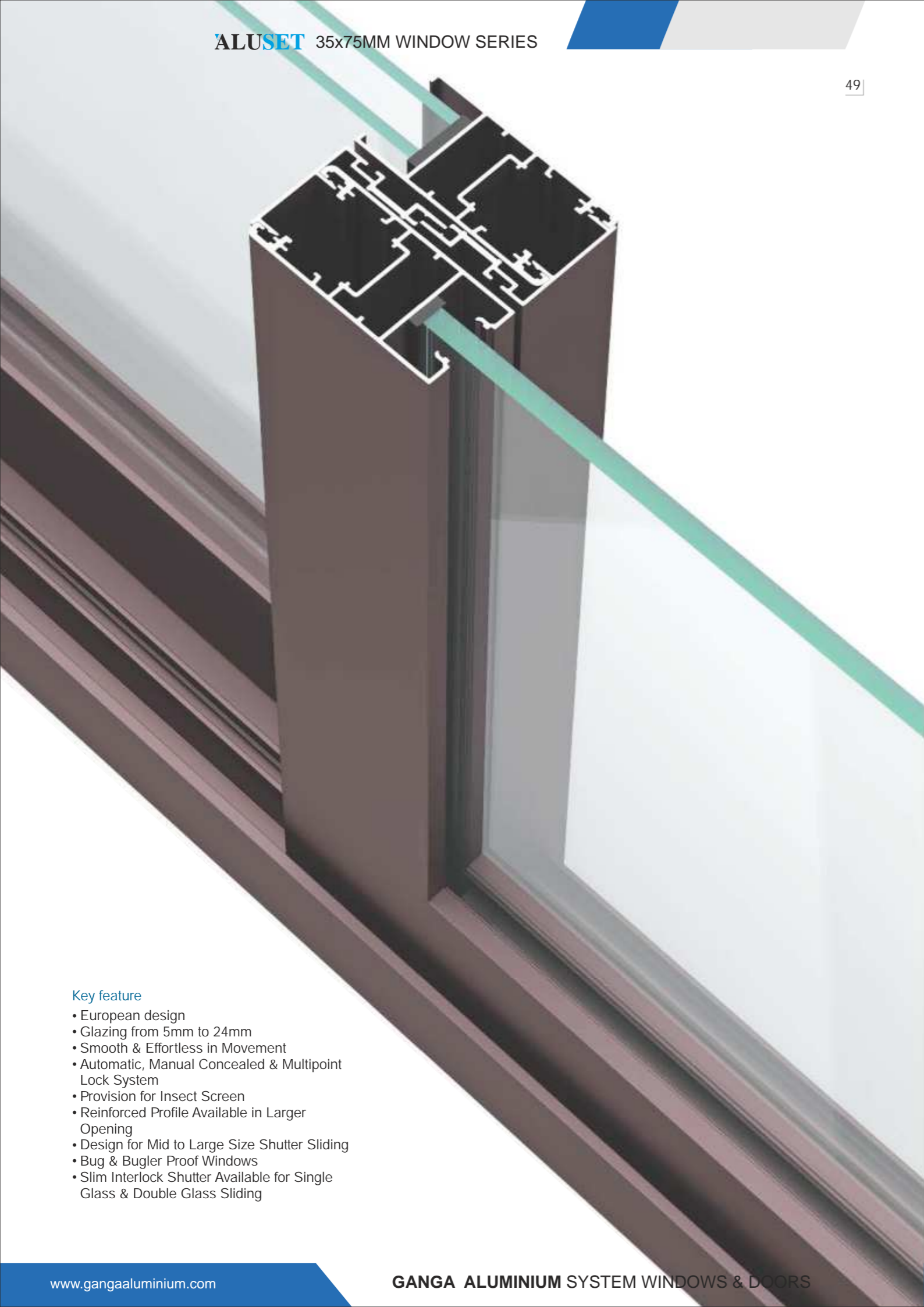

Key feature

- European design
- Glazing from 5mm to 24mm
- Smooth & Effortless in Movement
- Automatic, Manual Concealed & Multipoint Lock System
- Provision for Insect Screen
- Reinforced Profile Available in Larger Opening
- Design for Mid to Large Size Shutter Sliding
- Bug & Bugler Proof Windows
- Slim Interlock Shutter Available for Single Glass & Double Glass Sliding

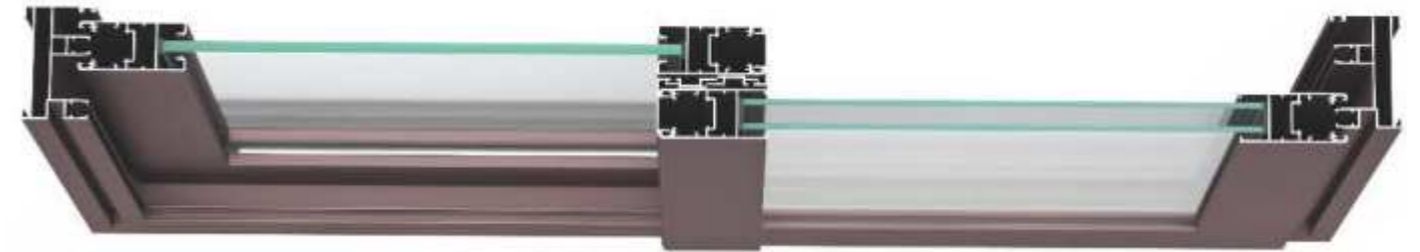

Top View

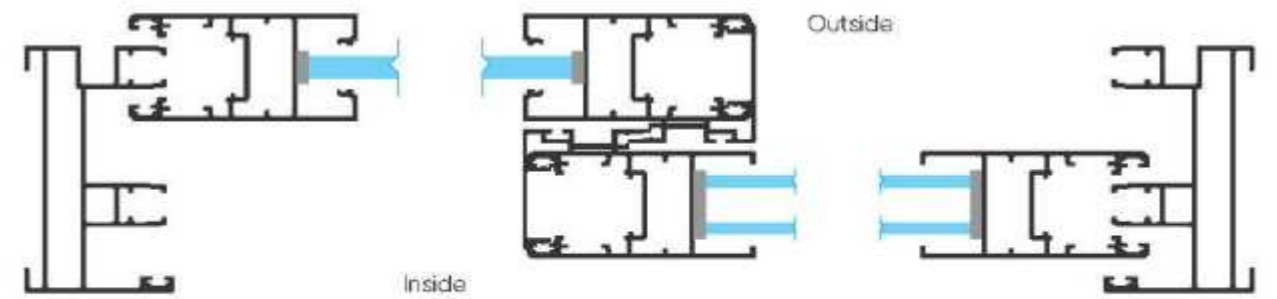

Inside

Outside

Side View

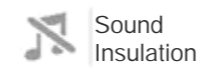

Sound Insulation



Air Permeability



Wind Load



Impact Resistance



Water Tightness

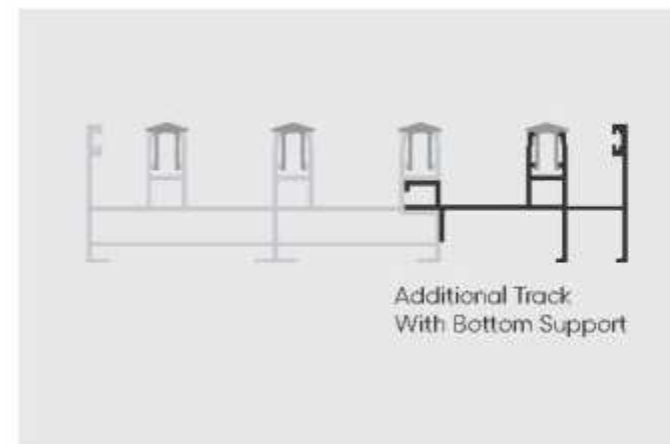
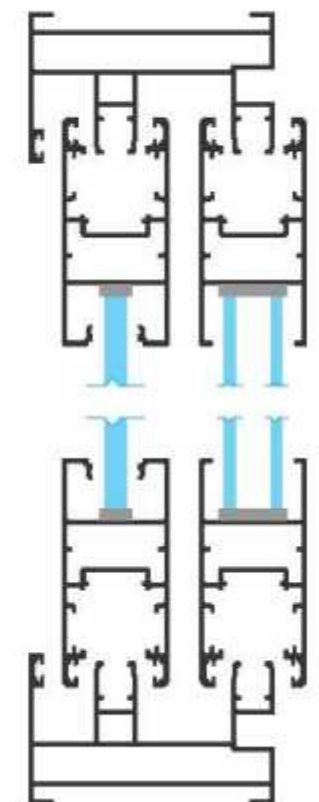

Additional Track With Bottom Support

TWO TRACK

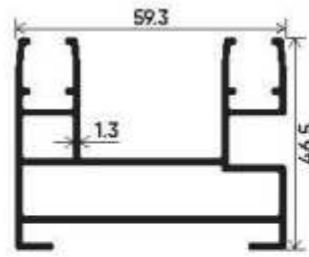

Basic Type
Section Number : V-3551
Weight (kg/mt) : 1.048

THREE TRACK

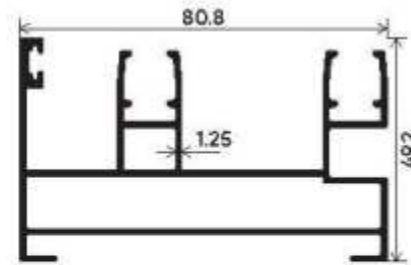

Premium Type
Section Number : V-3552
Weight (kg/mt) : 1.230

THREE TRACK

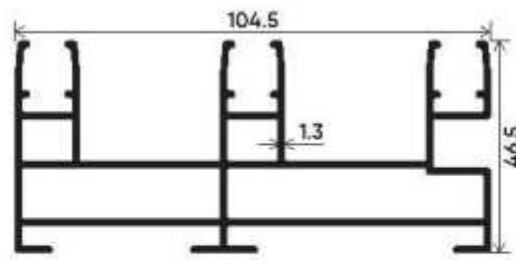

Basic Type
Section Number : V-3555
Weight (kg/mt) : 1.722

THREE TRACK

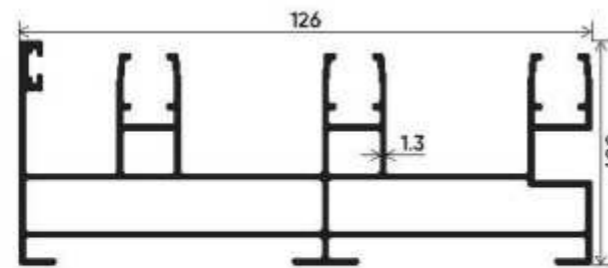

Premium Type
Section Number : V-3556
Weight (kg/mt) : 1.950

SHUTTER

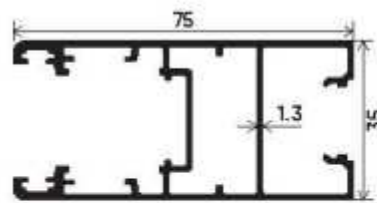

Single Glass Shutter
Section Number : V-3561
Weight (kg/mt) : 1.101

SHUTTER

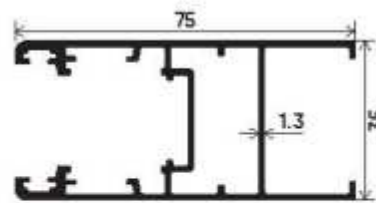

DGU Shutter
Section Number : V-3562
Weight (kg/mt) : 1.023

SHUTTER

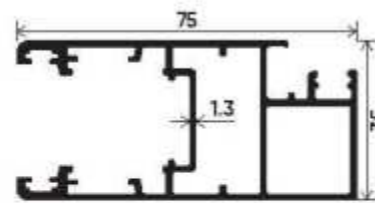

Mosquito Shutter
Section Number : V-3563
Weight (kg/mt) : 1.123

CLIP

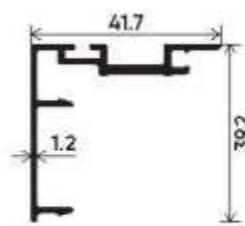

Universal Clip
Section Number : V-3571
Weight (kg/mt) : 0.409

TRACK RAIL CAP



"V" Type Track Rail Cap
Section Number : V-3581
Weight (kg/mt) : 0.157

Additional Track



Additional Track
Section Number : V-3560
Weight (kg/mt) : 0.956

MEETING SECTION

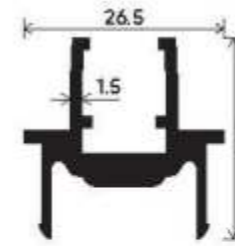

Center Opening Meeting Section
Section Number : V-3225
Weight (kg/mt) : 0.464

ADAPTOR

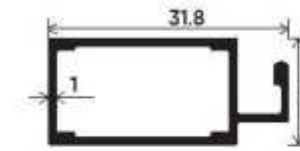

Mosquito Screen Adaptor
Section Number : V-3564
Weight (kg/mt) : 0.259

SHUTTER CUP



Mosquito Shutter Clip
Section Number : V-2514
Weight (kg/mt) : 0.144

LOCKING ROD

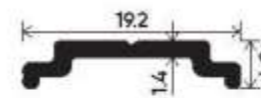

15 x 20 Euro Groove
Section Number : V-2551
Weight (kg/mt) : 0.156

GEORGIAN BAR

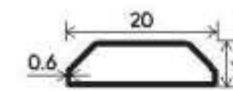

Georgian Bar
Section Number : V-2556
Weight (kg/mt) : 0.073

GEORGIAN BAR

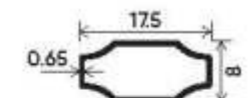

Georgian Bar
Section Number : V-2557
Weight (kg/mt) : 0.07



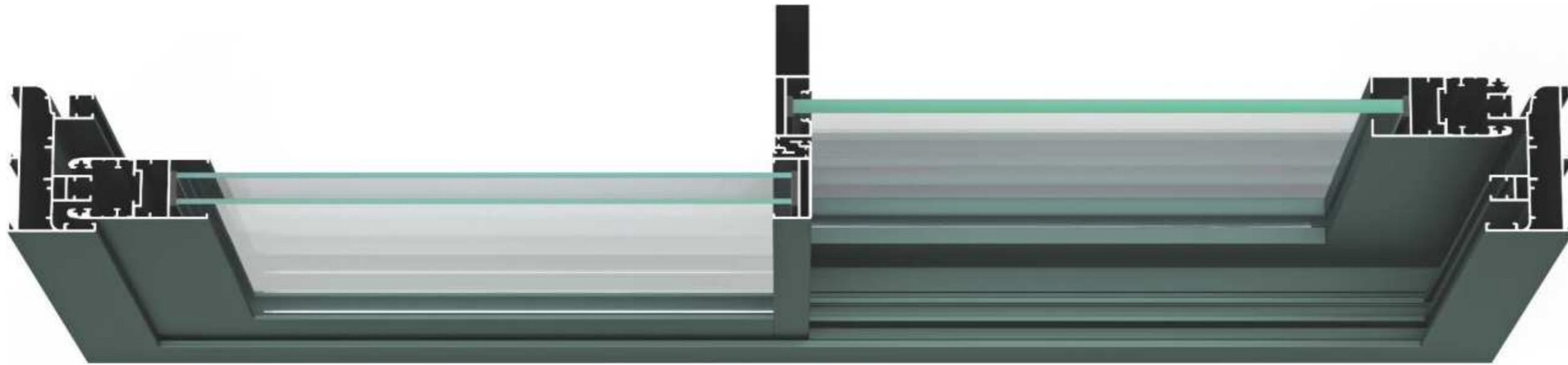

Top View

37mm Two Track Shutter Assemble

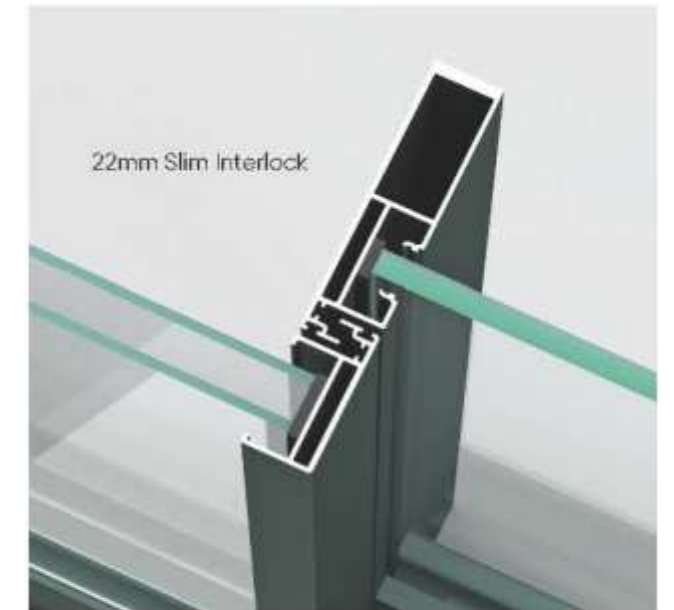
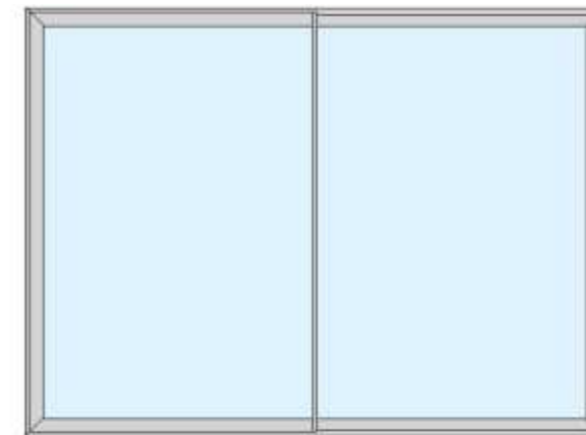
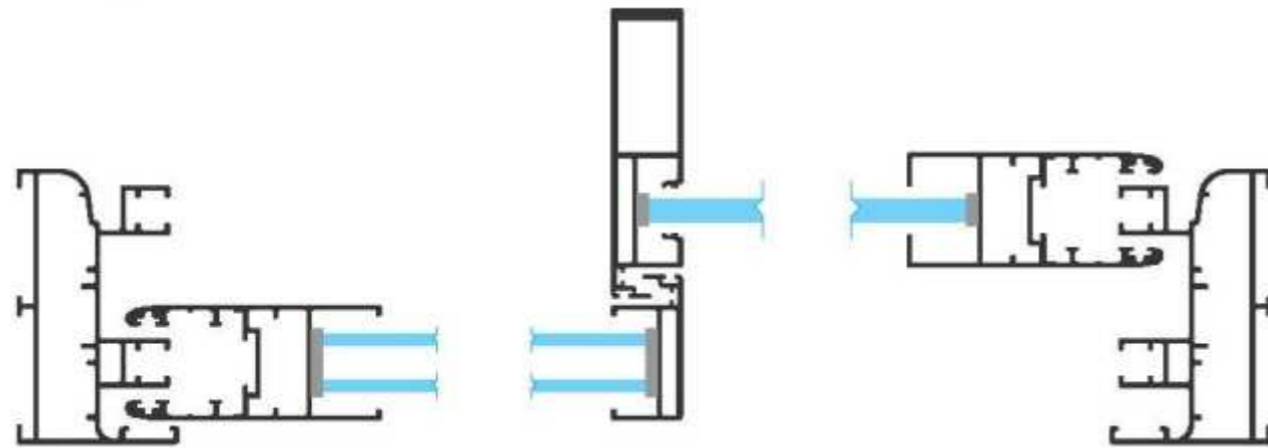

Key feature

- European design
- Glazing from 5mm to 24mm
- Smooth & Effortless in Movement
- Automatic, Manual Concealed & Multipoint Lock System
- Provision for Insect Screen
- Reinforced Profile Available in Larger Opening
- Design for Mid to Large Size Shutter Sliding
- Bug & Bugler Proof Windows
- Slim Interlock Shutter Available for Single Glass & Double Glass Sliding

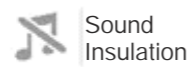

Sound Insulation



Air Permeability



Wind Load



Impact Resistance



Water Tightness

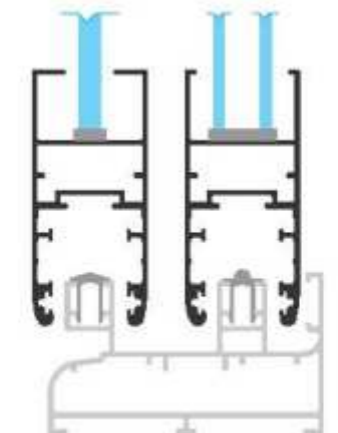

TWO TRACK

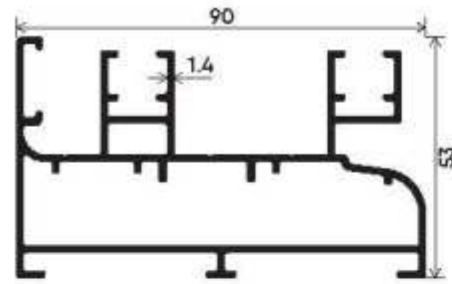

Premium Type
Section Number : V-3702
Weight (kg/mt) : 1.640

TWO TRACK SIDE

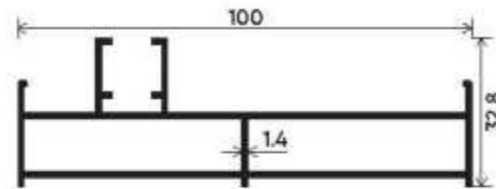

Vertical Track
Section Number : V-3501
Weight (kg/mt) : 1.134

THREE TRACK

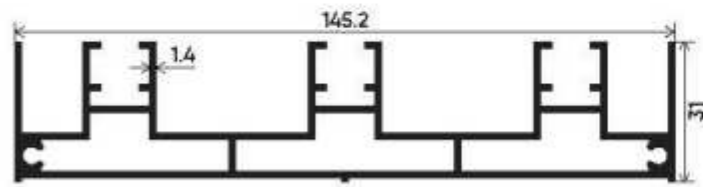

Top & Bottom Track
Section Number : V-3505
Weight (kg/mt) : 2.073

TWO TRACK

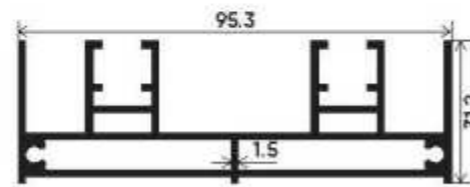

Top & Bottom Track
Section Number : V-3502
Weight (kg/mt) : 1.544

THREE TRACK SIDE

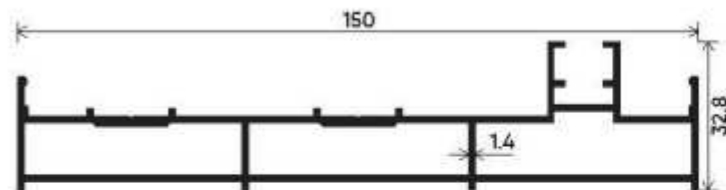

Vertical Track
Section Number : V-3503
Weight (kg/mt) : 1.566

THREE TRACK SIDE

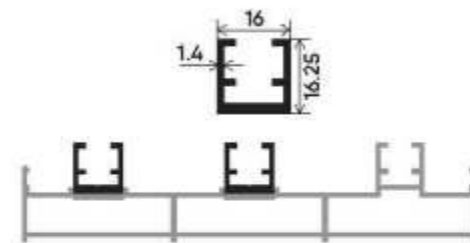

Vertical Track
Section Number : V-3504
Weight (kg/mt) : 0.245

THREE TRACK SIDE

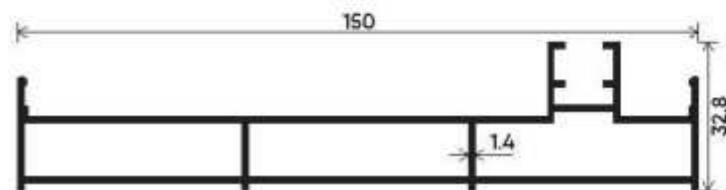

Plain Vertical Track
Section Number : V-3510
Weight (kg/mt) : 1.566

SHUTTER

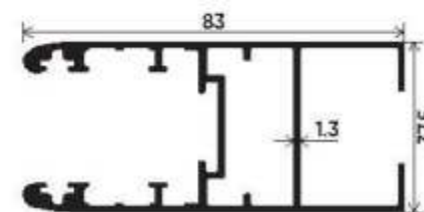

Single Glass Shutter
Section Number : V-3711
Weight (kg/mt) : 1.230

SHUTTER

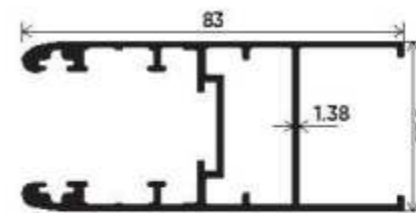

DGU Shutter
Section Number : V-3712
Weight (kg/mt) : 1.230

SHUTTER

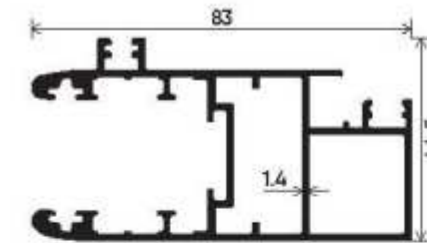

Mosquito Shutter
Section Number : V-3713
Weight (kg/mt) : 1.240

INTERLOCK

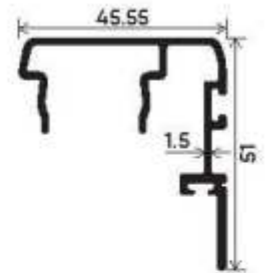

Universal Clip
Section Number : V-3771
Weight (kg/mt) : 0.683

INTERLOCK

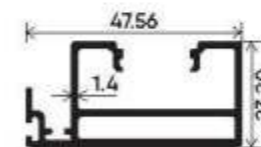

Slim Interlock SGU
Section Number : V-3722
Weight (kg/mt) : 0.684

INTERLOCK

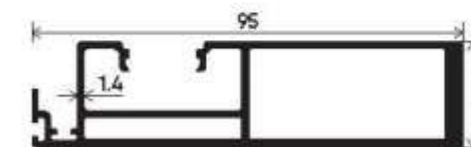

Box Reinforcement SGU
Section Number : V-3723
Weight (kg/mt) : 1.317

MEETING SECTION

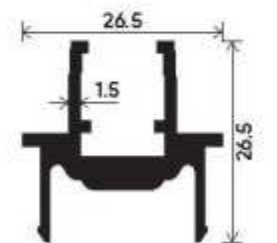

Center Opening Meeting Section
Section Number : V-3731
Weight (kg/mt) : 0.469

INTERLOCK

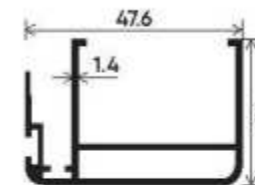

Slim Interlock DGU
Section Number : V-3724
Weight (kg/mt) : 0.642

INTERLOCK

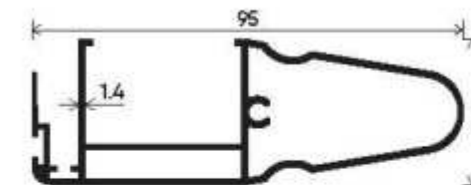

Box Reinforcement DGU
Section Number : V-3725
Weight (kg/mt) : 1.085

REDUCER CLIP

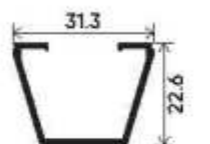

Reducer Clip
Section Number : V-3732
Weight (kg/mt) : 0.249

TRACK RAIL CLIP

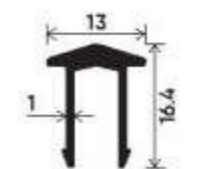

"V" Type
Section Number : V-2531
Weight (kg/mt) : 0.156

TRACK RAIL CLIP

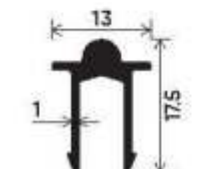

"U" Type
Section Number : V-2532
Weight (kg/mt) : 0.166

GEORGIAN BAR

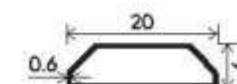

Georgian Bar
Section Number : V-2556
Weight (kg/mt) : 0.073

GEORGIAN BAR

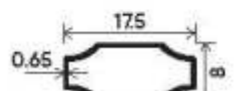

Georgian Bar
Section Number : V-2557
Weight (kg/mt) : 0.073



ALUSET

INGENUITY WITH ARTISTRY

Since opening up to an idea or an individual is one of the first steps in realizing our potential, strengths, and weaknesses, we are amply creative with the range of aluminium windows we offer.

You will find them to be durable, easy to maintain, and customizable. Your home's energy efficiency will be greatly improved by these windows, which are lightweight, weather resistant, and extremely energy efficient. There are numerous advantages to using aluminium as a building material in terms of its aesthetics, colour friendliness, and other features

CASEMENT WINDOW & DOOR

Your home's windows are its star attraction. Whether you live in a modern apartment or a historic Victorian terrace, your home's character and look are determined by its exterior. In addition to defining your home's appearance from the outside, windows allow you to see the world inside.

Technical Characteristics

Window Height (Max)
1530mm

Sash Height & Width
44mm / 28mm

Frame Height & Width
40mm / 28mm

Middle Height & Width
54mm / 28mm

Openable Sight Line
73mm

Corner Detail
• Frame Cutting 45 Degree
• Sash Cutting 45 Degree

Glass Range
• Single Glass Sash 6mm

Hardware
As per Euro Standard

Locking Options
Single Point & Multipoint

Sound
Insulation

Wind
Load

Air
Permeability

Impact
Resistance

Water
Tightness

Fix Windows

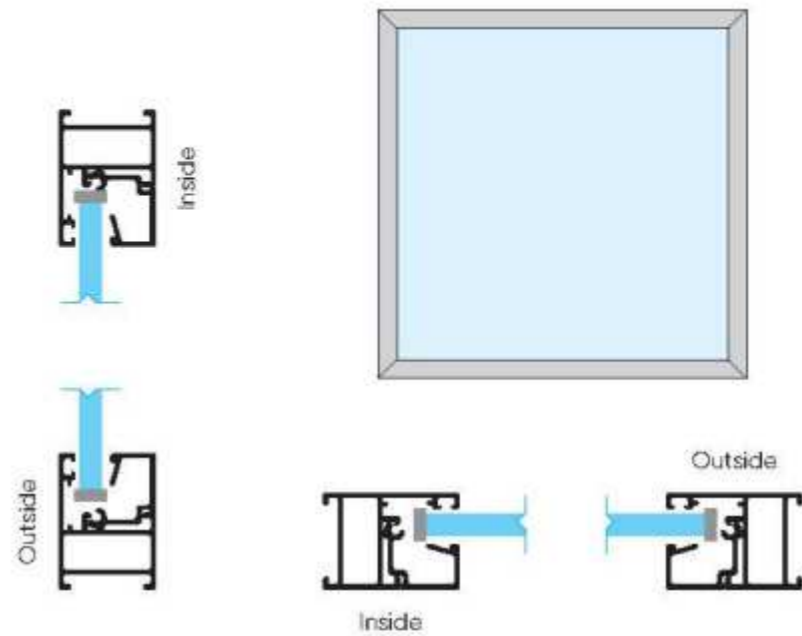

Side Opening Windows

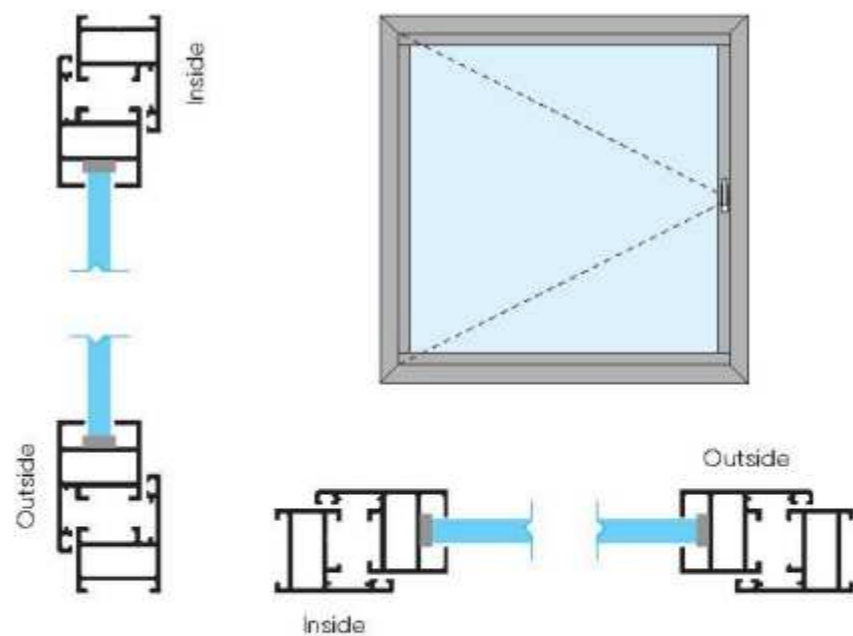

Top Hung Windows

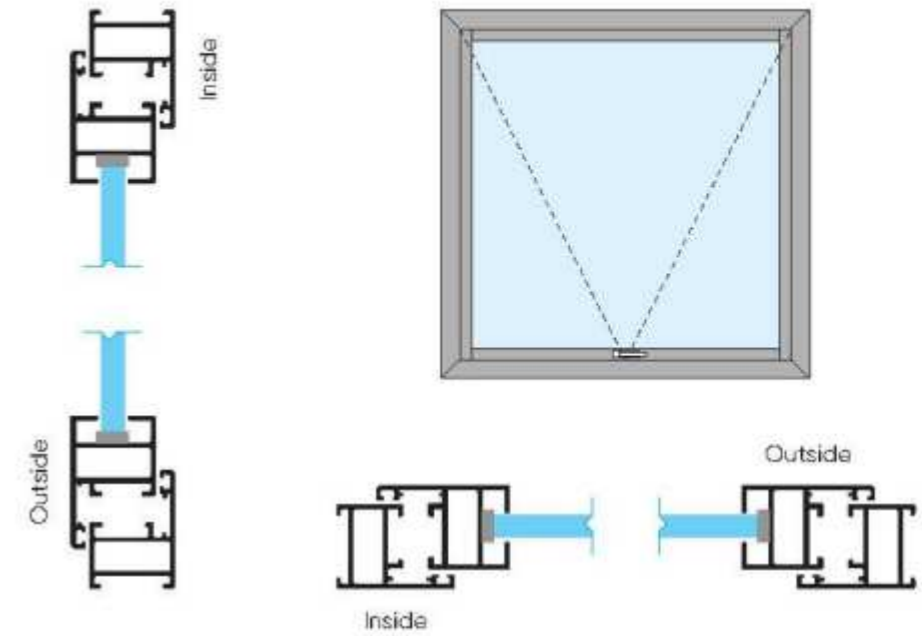

FRAME

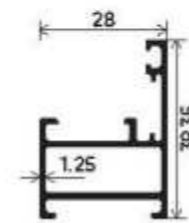

Outer Frame
Section Number : V-2801
Weight (kg/mt) : 0.520

SHUTTER

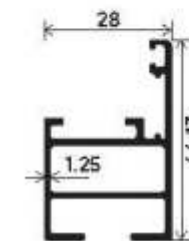

Outside Opening Shutter
Section Number : V-2802
Weight (kg/mt) : 0.583

MULLION

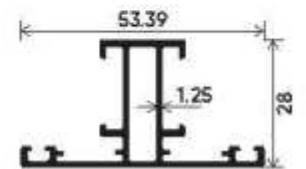

Eco Mullion
Section Number : V-2806
Weight (kg/mt) : 0.610

FRAME

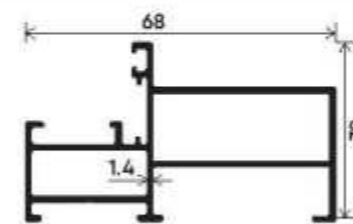

Eco Long Frame
Section Number : V-2805
Weight (kg/mt) : 0.725

CLIP

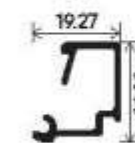

6mm Glass Clip
Section Number : V-2811
Weight (kg/mt) : 0.218

Key feature

- European design
- Glazing from 5mm to 24mm
- Square shapes Clip
- Glazing from inside for security
- Corner joint & T-Joint for stronger mechanical joinery
- Single point to Multipoint locking systems
- Smooth & effortless in operation
- Internal & External opening system
- Design for Medium opening & mid. wind load condition
- Bugler Proof Windows & Door system

 Sound Insulation

 Wind Load

 Air Permeability

 Impact Resistance

 Water Tightness



40mm Casement Windows With Flying Mullion with Grill

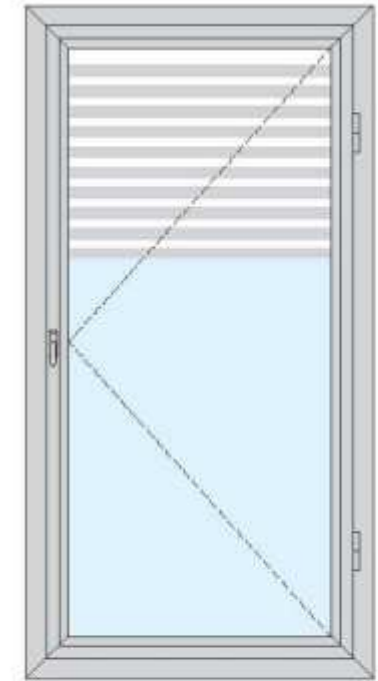
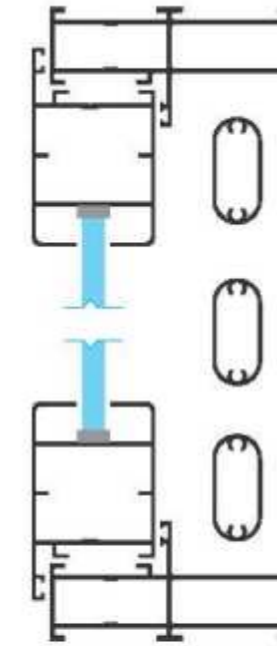

40mm Casement Windows With Flying Mullion

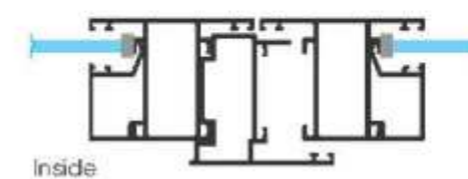
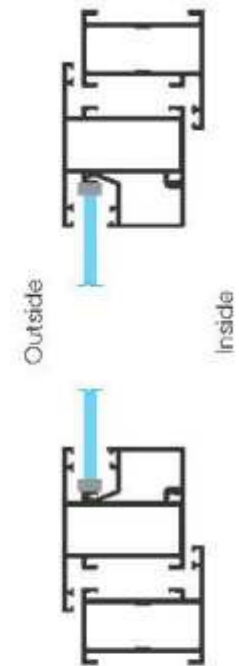
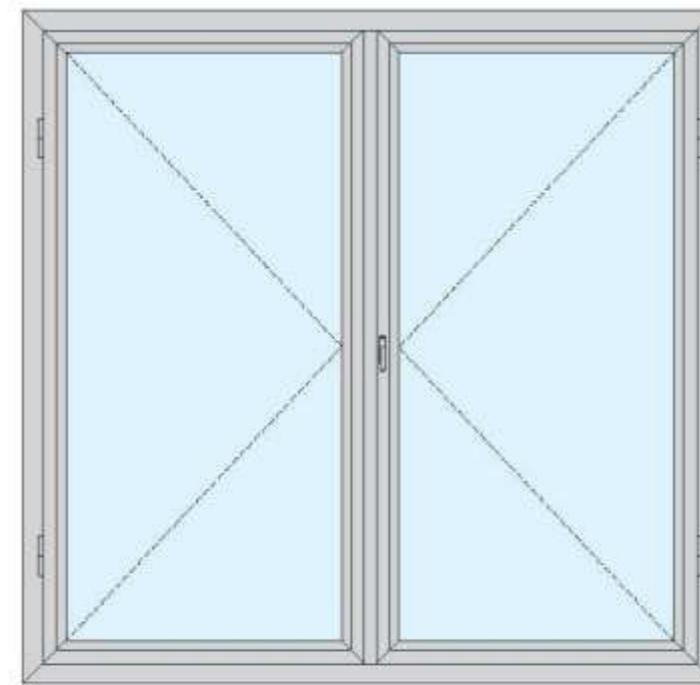

ECO FRAME OUTER

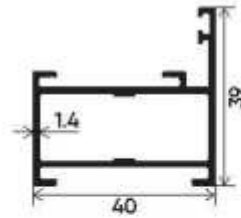

Eco Cutter Frame
Section Number : V-4001/1816
Weight (kg/mt) : 0.410

ECO FRAME OUTER

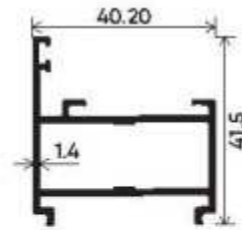

Eco Combination Frame
Section Number: V-4032
Weight (kg/mt) : 0.62

ECO MULLION

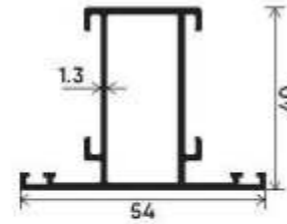

54mm Eco Mullion Section
Section Number : V-4003/1770
Weight (kg/mt) : 0.656

BOX FRAME

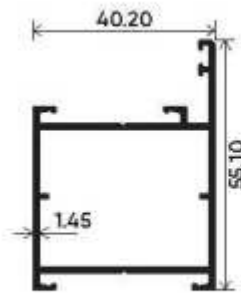

Door Frame
Section Number : V-4026
Weight (kg/mt) : 0.754

SHUTTER

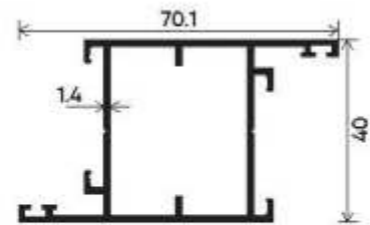

Inside Opening Shutter
Section Number : V-4031
Weight (kg/mt) :1.346

SHUTTER

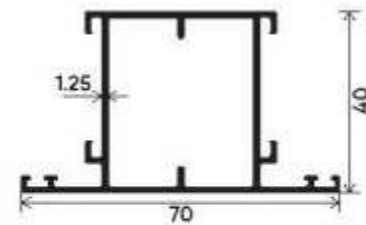

71mm Outside Shutter/Mullion
Section Number : V-4004
Weight (kg/mt) : 0.787

SHUTTER

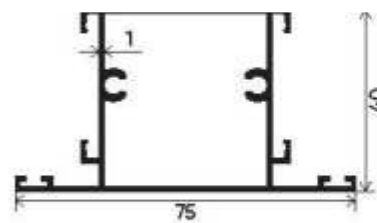

5mm-24mm Glass Shutter
Section Number : V-4007/1813
Weight (kg/mt) : 0.947

SHUTTER

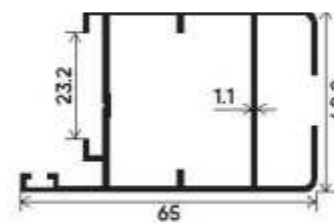

Mosquito screen Shutter
Section Number : V-4008/1811
Weight (kg/mt) : 0.929

INTERLOCK

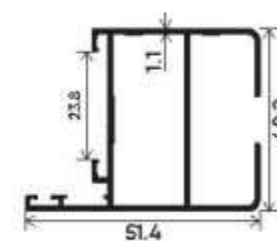

Single Glass Middle
Section Number : V-4009/1815
Weight (kg/mt) : 0.742

SHUTTER

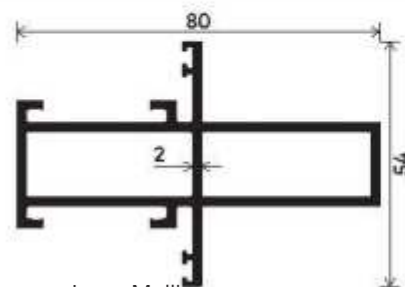

Long Mullion
Section Number : V-4034
Weight (kg/mt) :1.455

SHUTTER

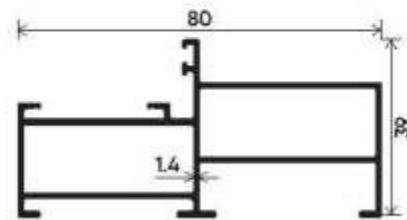

Eco Long Frame
Section Number : V-4030
Weight (kg/mt): 0.895

INTERLOCK

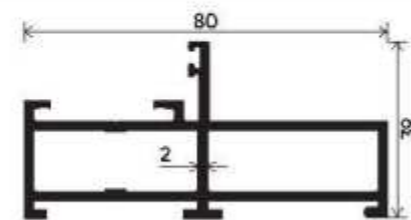

Eco Long Frame
Section Number : V-4033
Weight (kg/mt) :1.414

SHUTTER

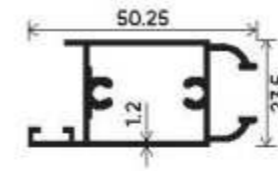

Mosquito Shutter
Section Number : V-4010/1355
Weight (kg/mt) : 0.669

ECO GLASS CLIP

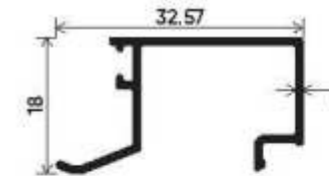

5mm-10mm Glass Clip
Section Number: V-4012/1818
Weight (kg/mt) :1.034

ECO GLASS CLIP

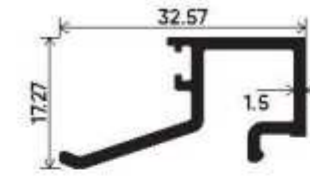

15mm Glass Clip
Section Number : V-4036
Weight (kg/mt) : 0.273

INTERLOCK CLIP

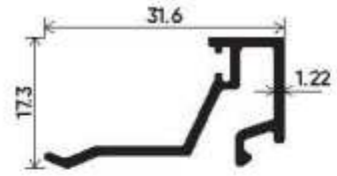

18mm-24mm Glass Clip
Section Number : V-4013
Weight (kg/mt) : 0.561

ECO CLIP

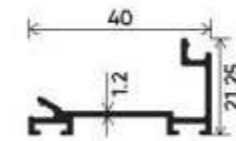

Shutter Bottom Clip
Section Number : V-4016
Weight (kg/mt) : 0.308

FLY MULLION

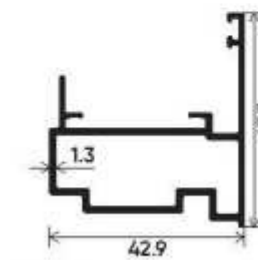

Fly Mullion
Section Number : V-4014
Weight (kg/mt) : 0.662

ADAPTOR

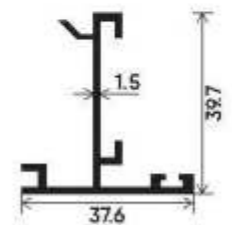

Reverse Adaptor
Section Number : V-4015
Weight (kg/mt) : 0.438

KPA MULLION

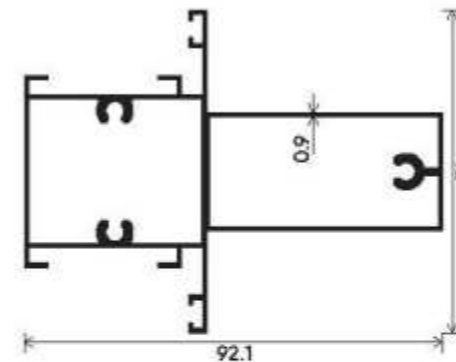

3 In 1 Mullion
Section Number :V-4005/1814
Weight (kg/mt) :1.285

ECO LONG FRAME

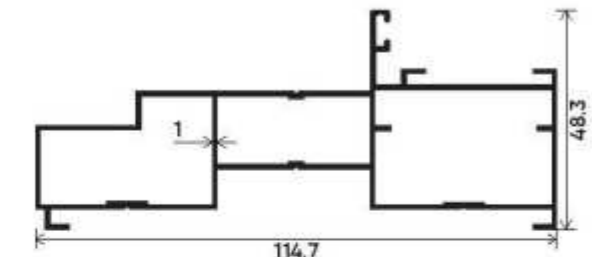

Security Grill & Mosquito Shutter
Section Number : V-4002/1810
Weight (kg/mt) :1.338

FRAME

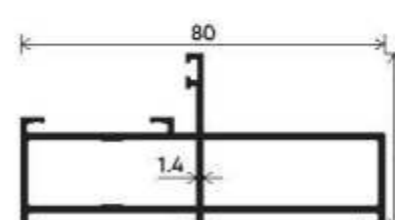

Eco Long Outer Frame
Section Number : V-4023
Weight (kg/mt) :1.005

LOCKING ROD



Euro Groove Locking Rod
Section Number : V-4021
Weight (kg/mt): 0.163

MULLION

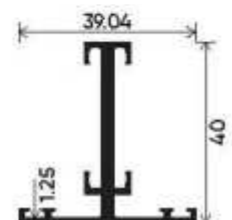

Mullion Section
Section Number : V-4022
Weight (kg/mt) : 0.553

Key feature

- European design
- Glazing from 5mm to 38mm
- Tilt & Turn system Compatible
- Molding & Square shapes Clip
- Glazing from inside for security
- Corner joint & T-Joint for stronger mechanical joinery
- Single point to Multipoint locking systems
- Smooth & effortless in operation
- Internal & External opening system
- Design for larger opening & high wind load condition
- Bugler Proof Door system

- Sound Insulation
- Air Permeability
- Wind Load
- Impact Resistance
- Water Tightness



Windows

50mm Casement Windows Fix + Outside Openble

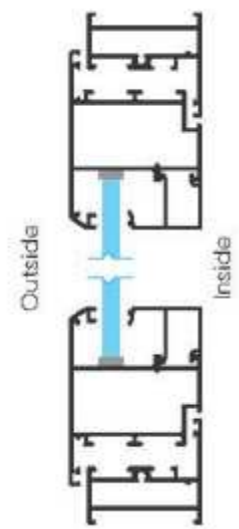
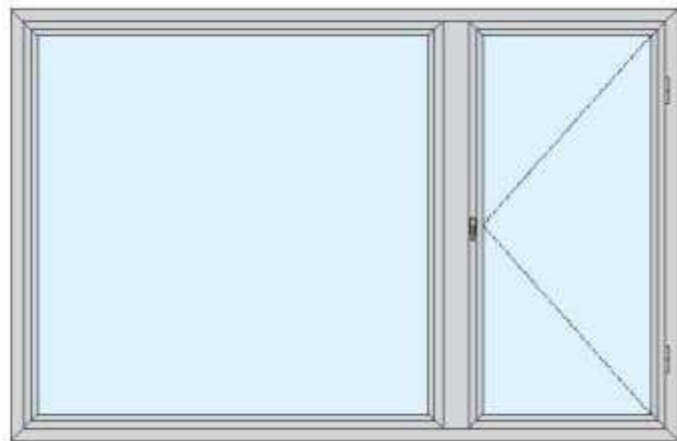

50mm Casement Double Door with Flying Mullion

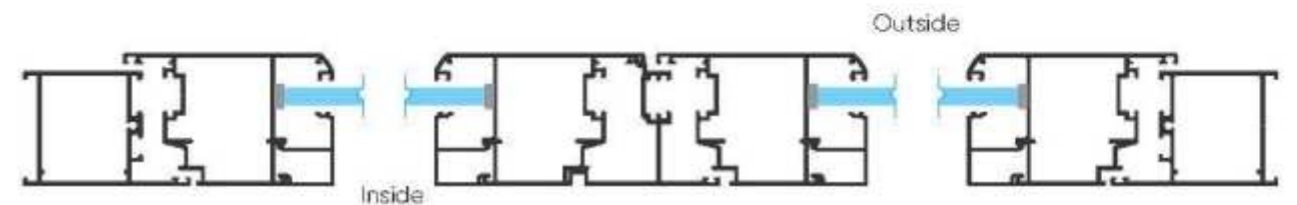
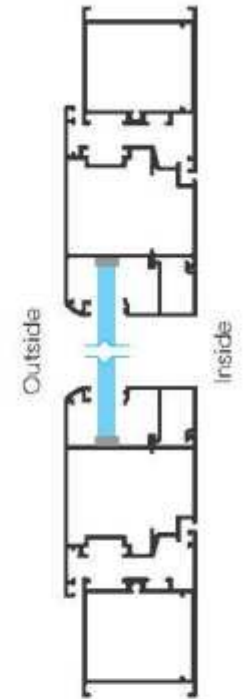
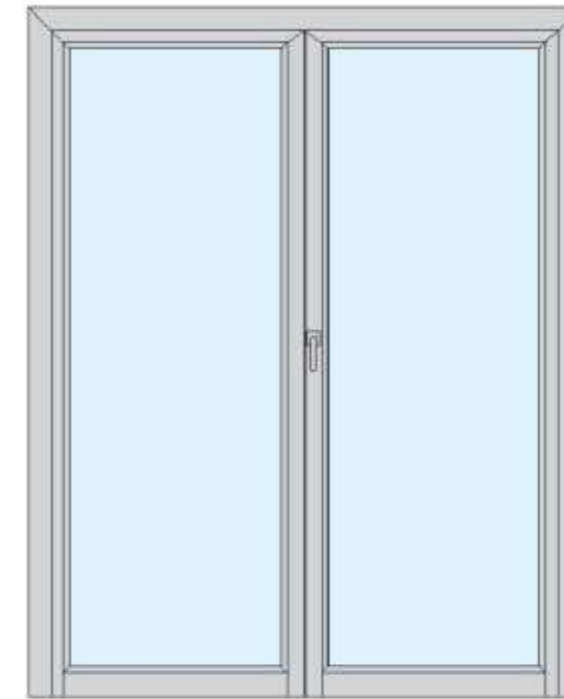

Key feature

- European design
- Glazing from 5mm to 38mm
- Tilt & Turn system Compatible
- Molding & Square shapes Clip
- Glazing from inside for security
- Corner joint & T-Joint for stronger mechanical joinery
- Single point to Multipoint locking systems
- Smooth & effortless in operation
- Internal & External opening system
- Design for larger opening & high wind load condition
- Bugler Proof Door system

- Sound Insulation
- Air Permeability
- Wind Load
- Impact Resistance
- Water Tightness

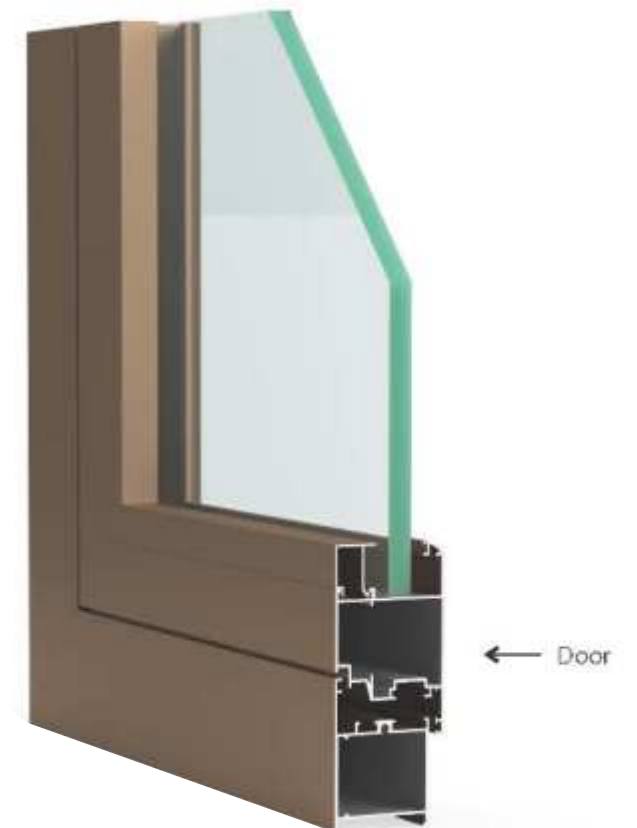

Door

FRAME

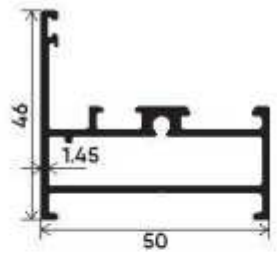

Outer Frame
Section Number : V-5101
Weight (kg/mt) : 0.868

SHUTTER

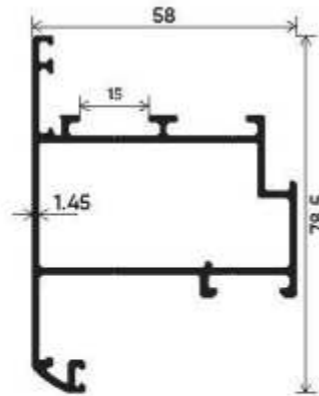

Outside Opening Shutter
Section Number: V-5102
Weight (kg/mt) :1.134

MULLION

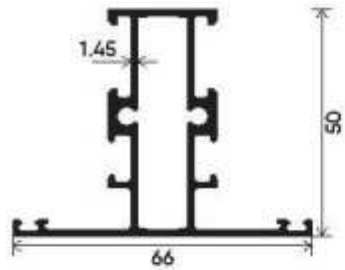

50mm x 65mm Mullion
Section Number : V-5103
Weight (kg/mt) :1.089

FRAME

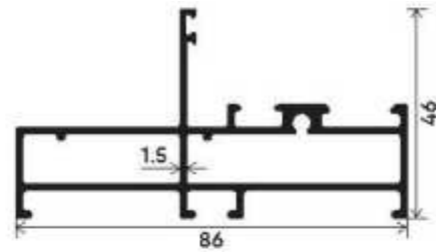

Combination Frame
Section Number : V-5104
Weight (kg/mt) :1.654

FRAME

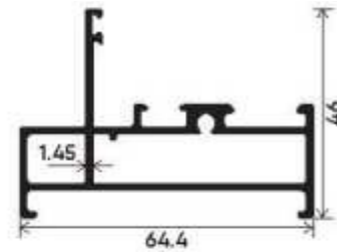

Combination Frame 64mm
Section Number : V-5107
Weight (kg/mt) : 0.956

FRAME

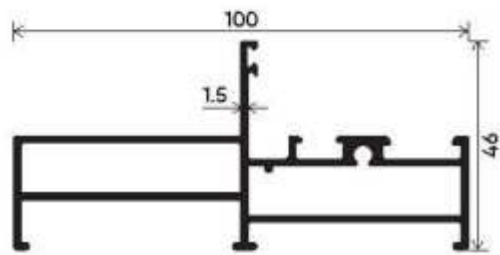

Combination Frame
Section Number : V-5105
Weight (kg/mt) :1.336

FRAME

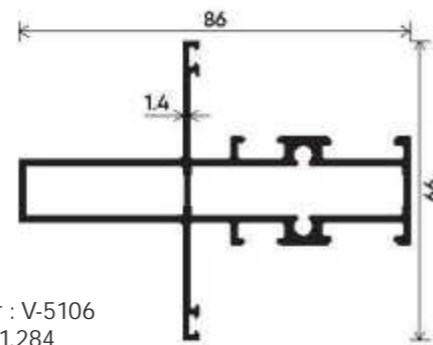

86mm Frame
Section Number : V-5106
Weight (kg/mt) :1.284

SHUTTER

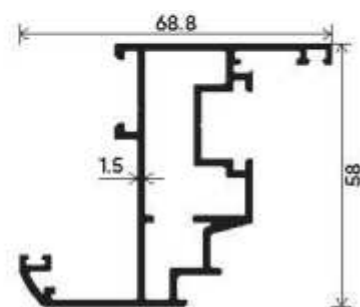

Tilt & Turn
Section Number : V-5111
Weight (kg/mt) :1.133

Tilt & Turn Window

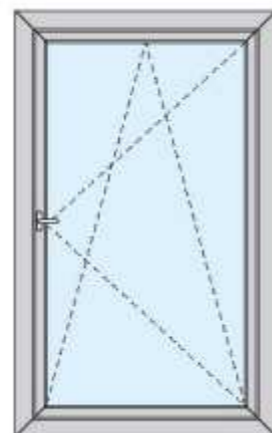

BOX FRAME

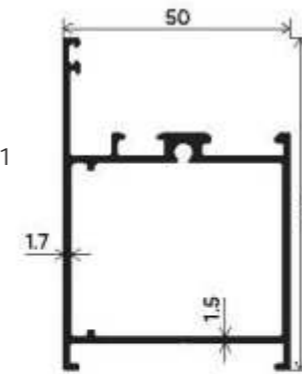

Door Frame
Section Number : V-5001
Weight (kg/mt) :1.076

SHUTTER

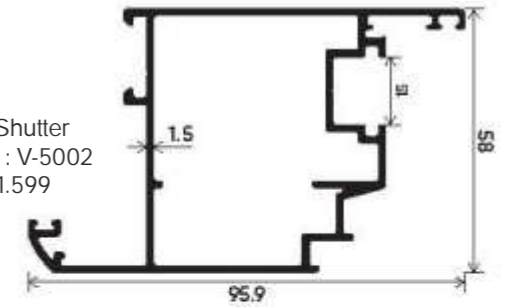

Inside Opening Shutter
Section Number : V-5002
Weight (kg/mt) :1.599

SHUTTER

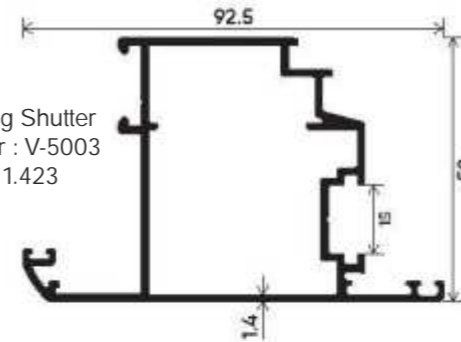

Outside Opening Shutter
Section Number : V-5003
Weight (kg/mt) :1.423

MULLION

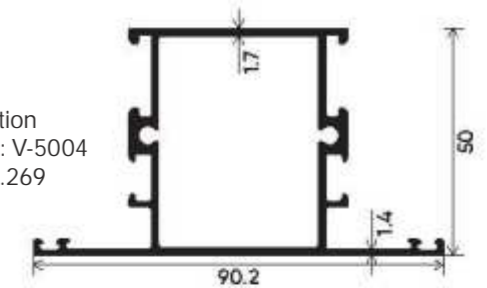

Door Middle Section
Section Number : V-5004
Weight (kg/mt) :1.269

BOTTOM

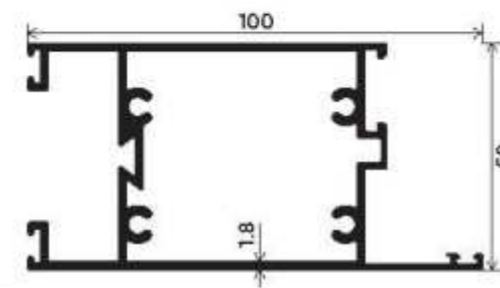

Door Bottom
Section Number : V-5005
Weight (kg/mt) : 0.732

ADAPTER

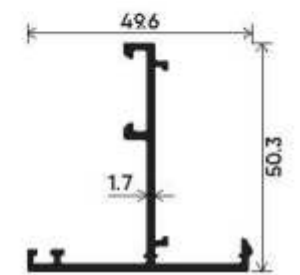

Reverse Adapter
Section Number : V-5012
Weight (kg/mt) : 0.497

MULLION

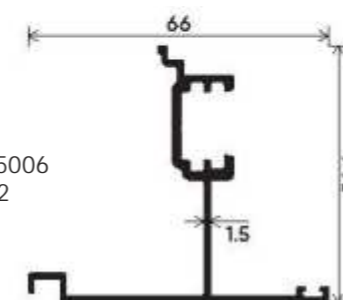

Euro Fly Mullion
Section Number : V-5006
Weight (kg/mt) :0.732

SHUTTER CLIP

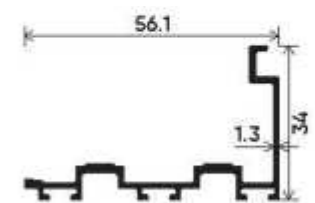

Door Bottom Adapter
Section Number : V-5007
Weight (kg/mt) : 0.532

SHUTTER

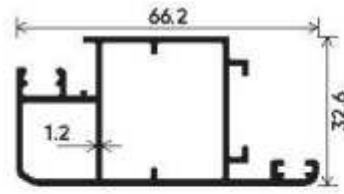

Mesh Shutter
Section Number : V-5113
Weight (kg/mt) : 0.779

FRAME

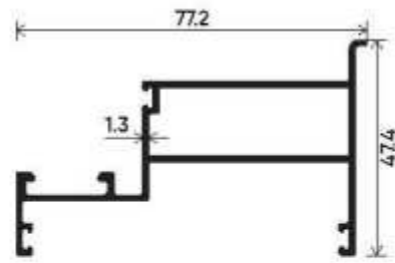

Combination Frame
Section Number : V-5112
Weight (kg/mt) : 0.859

SHUTTER CLIP

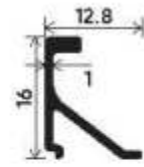

Mosquito Shutter Clip
Section Number : V-2514
Weight (kg/mt) : 0.144

Combination Window Assembly

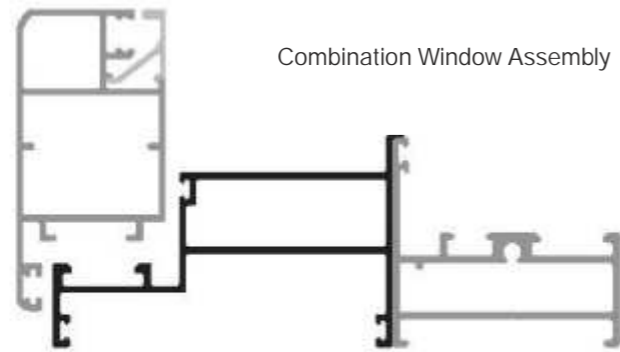

CLIP

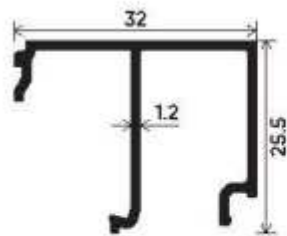

4mm-10mm Glass Clip
Section Number : V-5009
Weight (kg/mt) : 0.303

CLIP

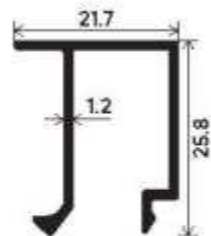

10mm-16mm Glass Clip
Section Number : V-5011
Weight (kg/mt) : 0.241

CLIP

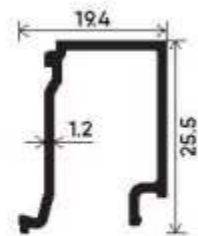

18mm-24mm Glass Clip
Section Number : V-5008
Weight (kg/mt) : 0.226

CLIP

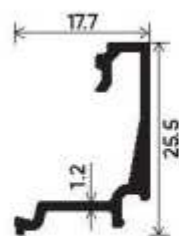

35mm Glass Clip
Section Number : V-5015
Weight (kg/mt) : 0.198

CLIP

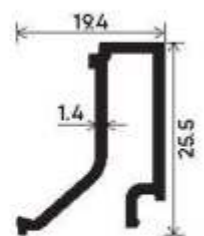

30mm Glass Clip
Section Number : V-5014
Weight (kg/mt) : 0.247

GLASS CLIP

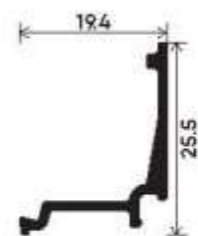

40mm Glass Round Clip
Section Number : V-5013
Weight (kg/mt) : 0.173

LOCKING ROD

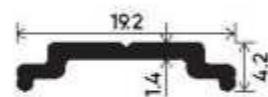

15x20 Euro Groove
Section Number : V-2551
Weight (kg/mt) : 0.156

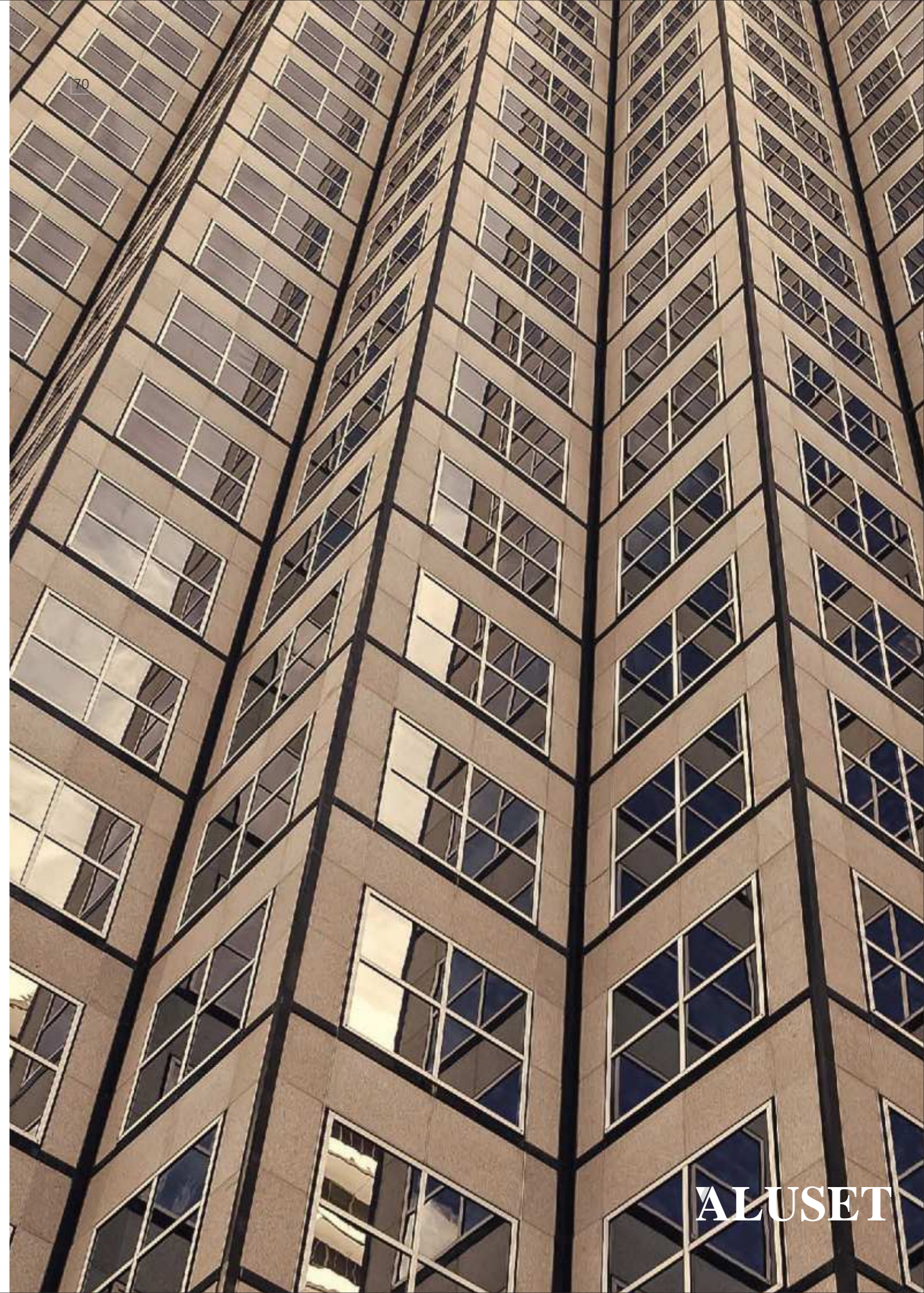



Key feature

- European design
- Glazing from 5mm to 36mm
- Top sliding system
- Molding & Square shapes Clip
- Glazing from inside for security
- Corner joint & T-Joint for stronger mechanical joinery
- Single point to Multipoint locking systems
- Smooth & effortless in operation
- Internal & External opening system
- Design for larger opening & high wind load condition
- Bugler Proof Door system

Sound Insulation

Air Permeability

Wind Load

Impact Resistance

Water Tightness

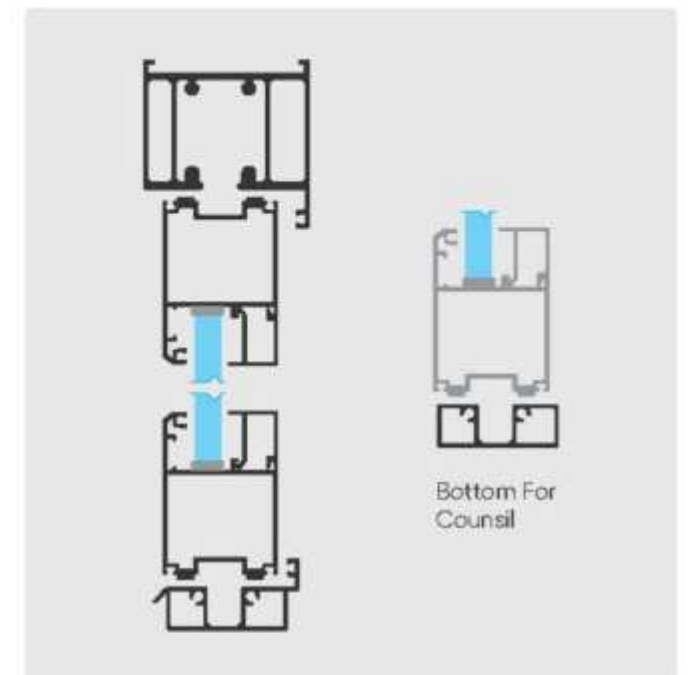
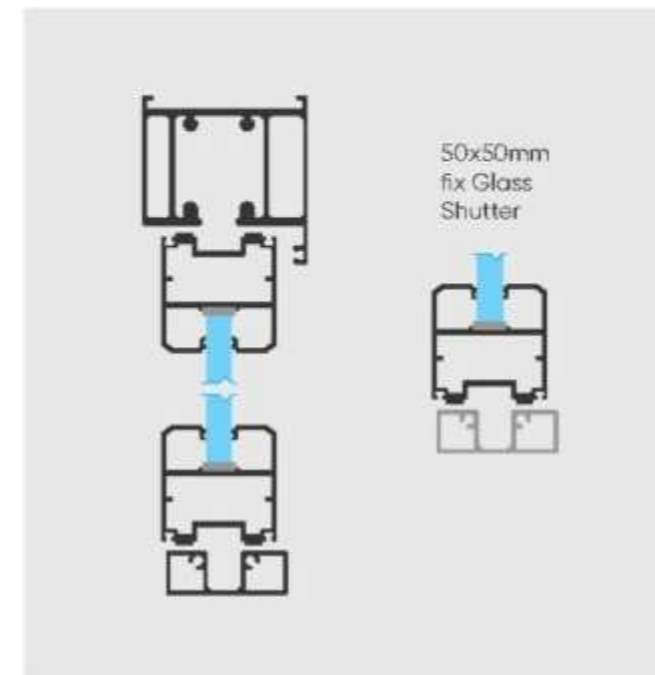

Top View

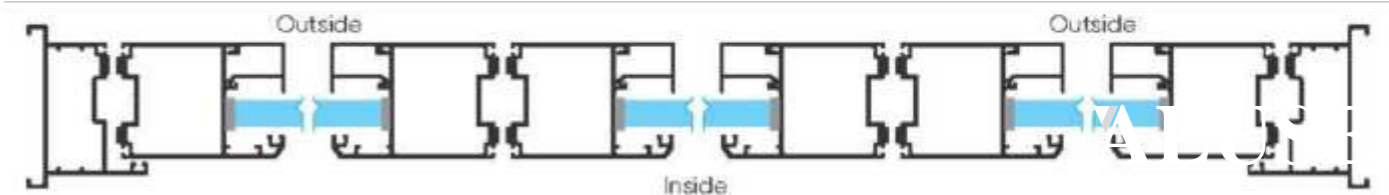

TOP

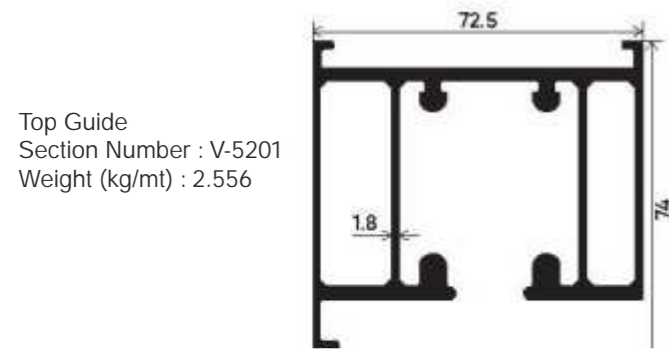

Top Guide
Section Number : V-5201
Weight (kg/mt) : 2.556

FRAME

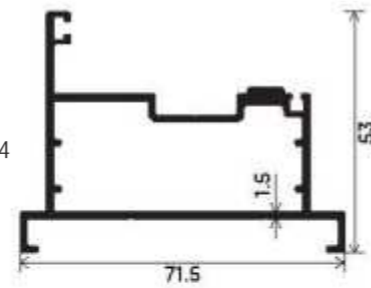

Vertical Frame
Section Number : V-5204
Weight (kg/mt) : 1.065

SHUTTER

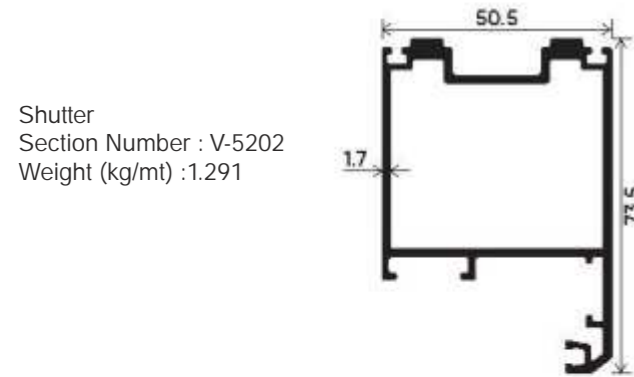

Shutter
Section Number : V-5202
Weight (kg/mt) : 1.291

SHUTTER

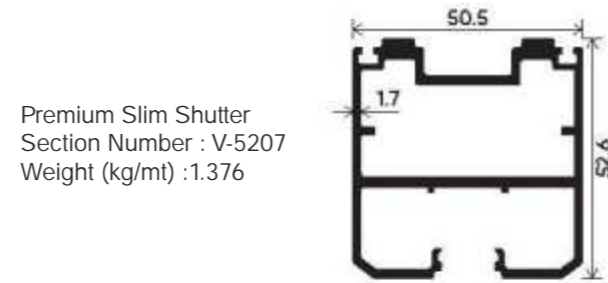

Premium Slim Shutter
Section Number : V-5207
Weight (kg/mt) : 1.376

BOTTOM

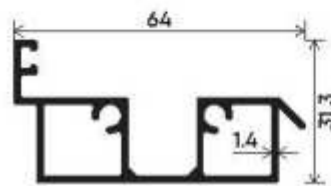

Bottom Guide
Section Number : V-5203
Weight (kg/mt) : 0.902

BOTTOM

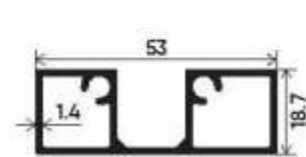

Premium Bottom Guide
Section Number : V-5205
Weight (kg/mt) : 0.660

S & F ADAPTOR

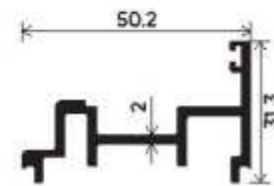

Door Adaptor
Section Number : V-5208
Weight (kg/mt) : 0.669

S & F

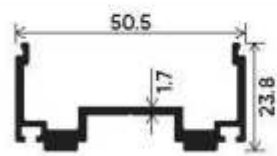

Center Opening Meeting
Section Number : V-5206
Weight (kg/mt) : 0.586

CLIP

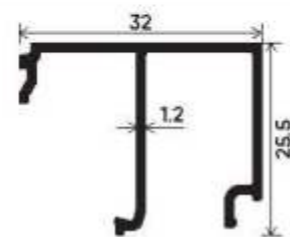

8mm Glass Gap
Section Number : V-5009
Weight (kg/mt) : 0.303

CLIP

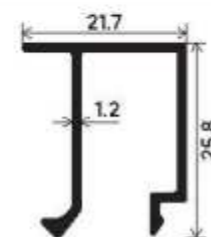

19mm Glass Gap
Section Number : V-5011
Weight (kg/mt) : 0.241

CLIP

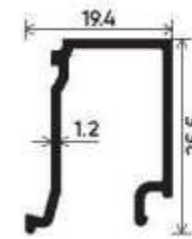

24mm Glass Gap
Section Number : V-5008
Weight (kg/mt) : 0.226

CLIP

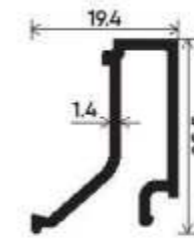

30mm Glass Gap
Section Number : V-5014
Weight (kg/mt) : 0.247

CLIP

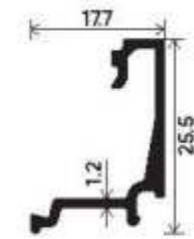

33mm Glass Gap
Section Number : V-5015
Weight (kg/mt) : 0.198

GLASS CLIP

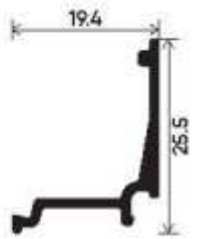

38mm Glass Gap
Section Number : V-5013
Weight (kg/mt) : 0.173



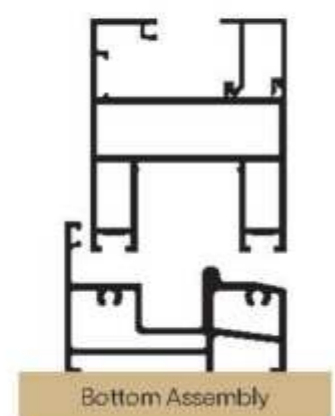
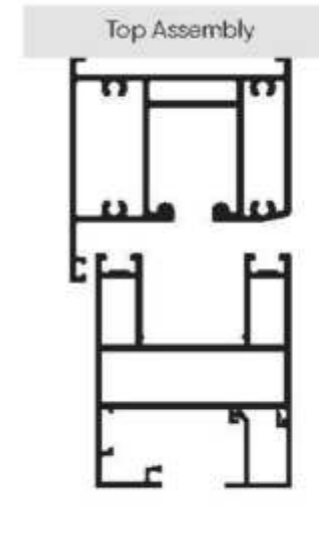

3+1 Assembly Heavy Duty System



TOP

BOTTOM

VERTICAL

SHUTTER

Top Guide
Section Number : V-6501
Weight (kg/mt) : 2.418

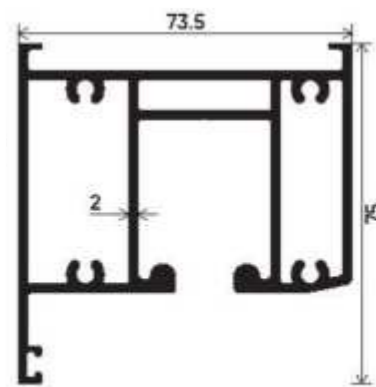

Bottom Frame
Section Number : V-6502
Weight (kg/mt) : 1.612

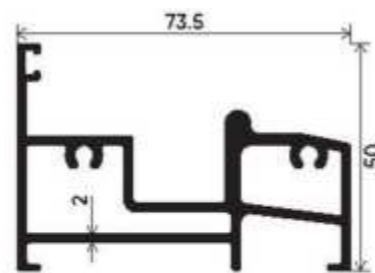

Vertical Frame
Section Number : V-6503
Weight (kg/mt) : 1.314

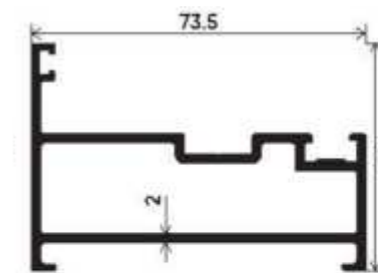

Shutter
Section Number : V-6504
Weight (kg/mt) : 2.032

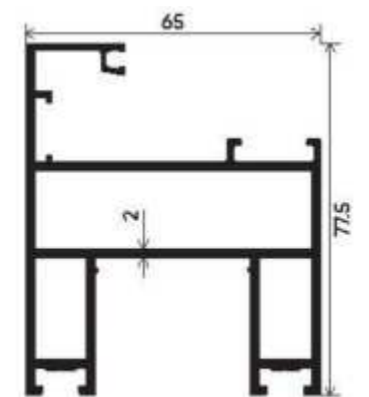

S & F ADAPTOR

S & F ADAPTOR

CLIP

CLIP

CLIP

CLIP

CLIP

CLIP

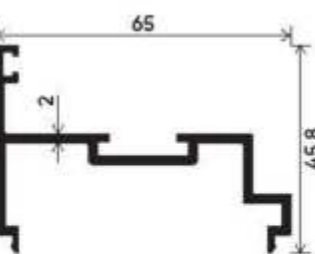

Door Adaptor
Section Number : V-6505
Weight (kg/mt) : 0.817

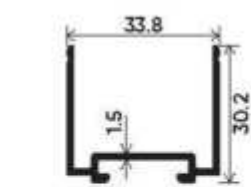

Lock Adaptor
Section Number : V-6506
Weight (kg/mt) : 0.407

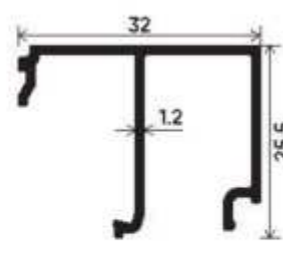

10mm Glass Gap
Section Number : V-5009
Weight (kg/mt) : 0.303

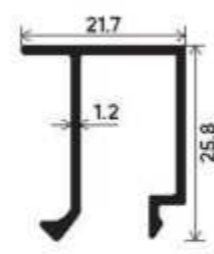

20mm Glass Gap
Section Number : V-5011
Weight (kg/mt) : 0.241

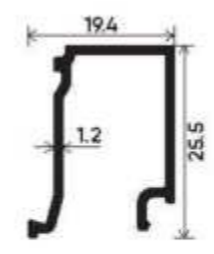

26mm Glass Gap
Section Number : V-5008
Weight (kg/mt) : 0.226

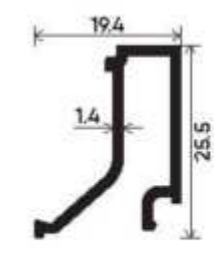

32mm Glass Gap
Section Number : V-5014
Weight (kg/mt) : 0.247

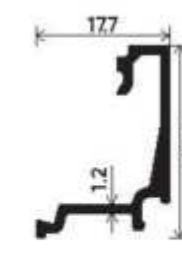

36mm Glass Gap
Section Number : V-5015
Weight (kg/mt) : 0.198

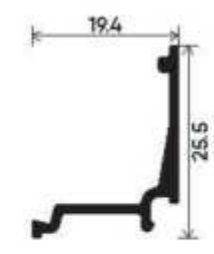

40mm Glass Gap
Section Number : V-5013
Weight (kg/mt) : 0.173

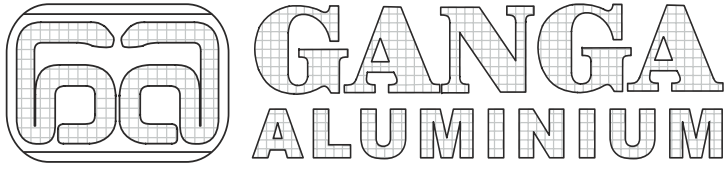

ALUSET

Office Vadodara Main Branch
D/4/5/6/7 Shreenath Puram,
Opp Central Ware House,
PVR Deep Multiplex,
Vadodara, Gujarat 390024

Mobile: +91 81415 76129
+91 98982 59440

Email: info@gangaaluminium.com
gangaaluminium@gmail.com

Office Bhopal
Elements The Designer Adobe
Plot No.. 150- A , Western Part L Ground
Vidhya Nagar Phase-11. Hoshangabad
Road Bhopal. Madhya Pradesh 462026

Mobile: +91 91115 33351

Scan QR



Website



YouTube



Instagram



Download
Broucher